





LUUZ



de proyecto

2021

ÍNDICE *INDEX*

 ALPHA 50	 BOMBILLAS BIG 82	 DUCK 25	 LUA 62	 SURF 86
 ARC 24	 CAM 86	 FRONT 36	 MARTÍN 42	 TAPE 32
 ARUMFIX 20	 CARMEN 56	 HOLE 86	 MILU 66	 THOR 30
 ASTON 44	 CARRY 80	 HOLEGLASS 31	 OBAN 76	 TRIME 70
 BECOOOL 71	 CIFO 53	 KIRA 54	 PEAK 36	 TURK 26
 BELOW 71	 CLARA 67	 KORU 74	 PLATE 34	 VALENTINA 57
 BELY 40	 COBMIST THIN 79	 LEEDS 76	 POPPINS 64	 VISIO 22
 BUGY 28	 CORK 77	 LINDEFIX 44	 RAYFIX 44	
 BOMBILLAS 84	 DOTFIX 14	 LINHA 48	 SAND 24	

LUZ DE PROYECTO

ES La luz como parte integrante e integradora de un espacio, así concebimos Luz de proyectos, como un encuentro entre la luz y la materia que lo envuelve para permitir el desarrollo de la vida en ese espacio que a su vez es entendido como un todo.

Las formas redondeadas y las líneas rectas equilibran esta colección en la que la luz cumple la forma que la transporta para transmitir el carácter de las cosas de manera inmediata. La luz dinamiza el espacio real y lo transforma en espacio potencial, siendo la puerta de acceso para la creación de experiencias en un espacio que previamente era solo un proyecto.

EN *Light as an integral and integrating part of a space, this is the concept behind Project Light, as an encounter between the light and the matter that surrounds it to allow the development of life in that space, which in turn is understood as a whole.*

Rounded shapes and straight lines balance this collection where light fulfils the form to transmit the character of things. Light energizes the real space and transforms it into potential space, becoming the gateway to the creation of experiences in a space that was previously only a project.

PT A luz como parte integrante de um espaço, concebemos assim Luz de Projectos, como um encontro entre a luz e a matéria que a rodeia para permitir o desenvolvimento da vida naquele espaço que por sua vez é entendido como um todo.

Formas arredondadas e linhas retas equilibram esta coleção em que a luz encontra a forma que a transporta para transmitir o caráter das coisas imediatamente. A luz revigora o espaço real e transforma-o em espaço potencial, sendo a porta de acesso para a criação de experiências num espaço que antes era apenas um projeto.

FR La lumière comme partie intégrante et intégratrice d'un espace; c'est ainsi que nous concevons Luz de proyectos, comme une rencontre entre la lumière et la matière qui l'entoure pour permettre de vivre dans cet espace qui à son tour est compris comme un tout.

Les formes arrondies et les lignes droites équilibrent cette collection dans laquelle la lumière rencontre la forme qui la transporte pour transmettre immédiatement le caractère des choses. La lumière dynamise l'espace réel et le transforme en espace potentiel, étant la porte d'accès pour la création d'expériences dans un espace qui n'était auparavant qu'un projet.







UNA VIDA DE LUZ

ES La evolución consiste en una serie de transformaciones continuas que va experimentando la naturaleza y los seres que la componen. Esto es precisamente lo que Carlos y Regina Schuller, fundadores de SÛLION, han ido haciendo a lo largo de estos últimos 50 años, adaptándose a los continuos cambios, pero siempre con un mismo objetivo: crear espacios únicos que destilen personalidad.

La luz de SÛLION se enciende en 1966, cuando Carlos y Regina abren su primer taller de ensamblado de lámparas en Madrid, al que llamaron "Lámparas Schuller" y que, poco a poco, fue creciendo hasta convertirse en un referente en el diseño y la confección de lámparas artesanales. Por sus manos han pasado las últimas tendencias en iluminación decorativa de los años 80 y 90, desde farolitos, hasta sus tan exitosas lámparas florentinas y Tiffanys, que exportaron al resto de países de Europa, y también a Asia, África y Latinoamérica.

El estilo aplicado en cada diseño y el cuidado en la elección de sus materiales puestos al servicio de la luz, junto con el tesón y el esfuerzo de la familia Schuller, han llevado a SÛLION a convertirse en lo que es hoy en día.

EN Evolution is made of a bunch of continuous changes in the nature and its living beings. This is exactly what Carlos and Regina Schuller, founders of SÛLION, have been doing these last 50 years, adapting to the continuous changes, but always with the same target: create unique spaces with strong personality.

The light of SÛLION was turned on in 1966, when Carlos and Regina Schuller opened their first workshop of lamps assembly in Madrid, they named it "Lámparas Schuller", and step by step started growing until it was leader in design and assembly of handmade lamps. By their hands last trends have passed of the years 80 and 90, from small lamps to successful Florentine lamps and Tiffanys, which they exported to other countries of Europe, and to Asia, Africa and Latin America.

The style applied in each design and the careful selection of the materials used for the lights, allied with the hard work and the effort of the Schuller family, have transformed SÛLION in what it is nowadays.



PT A evolução consiste em uma série de transformações contínuas pelas quais passam a natureza e os seres que a compõem. É precisamente isso que Carlos e Regina Schuller, fundadores do SÛLION, têm feito nos últimos 50 anos, adaptando-se a mudanças contínuas, mas sempre com o mesmo objetivo: criar espaços únicos que exalem personalidade.

A luz SÛLION foi acesa em 1966, quando Carlos e Regina abriram em Madrid a sua primeira oficina de montagem de lâmpadas, que chamaram de "Lâmpadas Schuller" e que, aos poucos, foi se tornando uma referência em design e fabricação de lâmpadas feitas à mão. As últimas tendências em iluminação decorativa dos anos 80 e 90 passaram por suas mãos, desde as lanternas até as luminárias Florentinas e Tiffany de grande sucesso, que exportou para outros países europeus, além da Ásia, África e América Latina.

O estilo aplicado em cada desenho e o cuidado na escolha dos materiais a serviço da luz, aliados à tenacidade e esforço da família Schuller, fizeram com que a SÛLION se tornasse o que é hoje.

FR L'évolution consiste en une série de transformations continues que subissent la nature et les êtres qui la composent. C'est précisément ce qu'ont fait Carlos et Regina Schuller, fondateurs de SÛLION, au cours des 50 dernières années, en s'adaptant aux changements continus, mais toujours avec le même objectif: créer des espaces uniques qui respirent la personnalité.

La lumière de SÛLION a été allumée en 1966, lorsque Carlos et Regina ont ouvert leur premier atelier d'assemblage de lampes à Madrid, atelier qu'ils ont appelé «Lámparas Schuller» et qui, petit à petit, est devenu une référence dans la conception et la fabrication de lampes artisanales. Les dernières tendances de l'éclairage décoratif des années 80 et 90 sont passées entre ses mains, tant pour les lustres, comme pour les lampes florentines et Tiffany à succès, qu'il a exportées dans d'autres pays européens, ainsi qu'en Asie, en Afrique et en Amérique latine.

Le style appliqué dans chaque conception et le soin dans le choix des matériaux au service de la lumière, ainsi que la ténacité et l'effort de la famille Schuller, ont conduit SÛLION à devenir ce qu'elle est aujourd'hui.



DÉJANOS ILUMINAR TU VIDA

ES En SÛLION damos luz a tus proyectos de renovación y reforma de hogares, oficinas, restaurantes, hoteles, etc. Nuestro equipo de lighting designers te acompañará en el desarrollo de tus ideas transformándolas en espacios vivos y con personalidad propia.

Trabajamos para ofrecerte las mejores soluciones de iluminación y ventilación, sin dejar de lado la eficiencia, la durabilidad y la elegancia. Entendemos la luz como energía que tiene el poder de transformar una casa en un hogar y la capacidad de enriquecer cada espacio creando emociones y sensaciones únicas.

PT Na SÛLION damos origem aos seus projetos de renovação e reforma de habitações, escritórios, restaurantes, hotéis, etc. A nossa equipa de designers de iluminação irá acompanhá-lo no desenvolvimento das suas ideias, transformando-as em espaços habitacionais com personalidade própria.

Trabalhamos para lhe oferecer as melhores soluções de iluminação e ventilação, sem descurar a eficiência, durabilidade e elegância. Entendemos a luz como a energia que tem o poder de transformar uma casa em um lar e a capacidade de enriquecer cada espaço criando emoções e sensações únicas.

EN At SÛLION we give light to your projects of renewal for homes, offices, restaurants, hotels... Our team of lighting designers will help you in the development of your ideas, transforming them into living places and with their own personality.

We offer the best solutions for lighting and ventilation, keeping in mind efficiency, durability, and elegance. We understand the light as energy, that have the power to transform a house in a home, and is also able to make each room better, creating unique feelings and sensation.

FR Chez SÛLION nous donnons naissance à vos projets de création et de réforme de foyers, bureaux, restaurants, hôtels, etc. Notre équipe de "lighting designers" vous accompagnera dans le développement de vos idées, en les transformant en espaces de vie ayant leur propre personnalité.

Nous travaillons pour vous offrir les meilleures solutions d'éclairage et de ventilation, sans négliger l'efficacité, la durabilité et l'élégance. Nous comprenons la lumière comme une énergie qui a le pouvoir de transformer une maison en un foyer et la capacité d'enrichir chaque espace en créant des émotions et des sensations uniques.



MIRAMOS AL FUTURO

REGINA
SCHULLER

ES Nuestra apuesta por el diseño, unido a la innovación y al desarrollo tecnológico, es una constante. Concebimos cada uno de nuestros productos como piezas únicas para personas que también lo son. Con esta filosofía nace **REGINA SCHULLER**, un proyecto que nos permite mirar al futuro manteniendo viva la esencia de nuestra marca.

REGINA SCHULLER es sinónimo de fuerza y de carácter, la expresión de la elegancia, combinada con la sencillez y la funcionalidad. Señas de identidad que son compartidas por nuestro equipo de profesionales que trabaja para construir hogares y estancias que den respuesta a las necesidades de las personas en su día a día.

EN *Our commitment to design, together with innovation and technological development, is a key component. We design each of our products as unique pieces for people who are also unique. **REGINA SCHULLER** was born with this philosophy, a project that allows us to look to the future while keeping the essence of our brand alive.*

Regina Schuller is synonymous of strength and character, the expression of elegance, combined with simplicity and functionality. Signs of identity that are shared by our team of professionals who work to build homes that respond to the needs of people in their daily lives.

PT *O nosso compromisso com o design, aliado à inovação e ao desenvolvimento tecnológico, é uma constante. Concebemos cada um dos nossos produtos como peças únicas para pessoas que também o são. **REGINA SCHULLER** nasceu com esta filosofia, um projeto que nos permite olhar para o futuro mantendo viva a essência da nossa marca.*

REGINA SCHULLER é sinônimo de força e caráter, expressão da elegância, aliada à simplicidade e funcionalidade. Sinais de identidade que são partilhados pela nossa equipa de profissionais que se dedica à construção de casas e quartos que respondam às necessidades das pessoas no seu dia-a-dia.

FR *Notre engagement pour le design, associé à l'innovation et au développement technologique, est une constante. Nous concevons chacun de nos produits comme des pièces uniques pour les personnes qui le sont aussi. **REGINA SCHULLER** est née avec cette philosophie, un projet qui nous permet de regarder vers l'avenir tout en gardant vivante l'essence de notre marque.*

REGINA SCHULLER est synonyme de force et de caractère, l'expression de l'élégance, allée à la simplicité et à la fonctionnalité. Des signes d'identité partagés par notre équipe de professionnels qui travaillent pour construire des foyers et des pièces qui répondent aux besoins des personnes dans leur vie quotidienne.

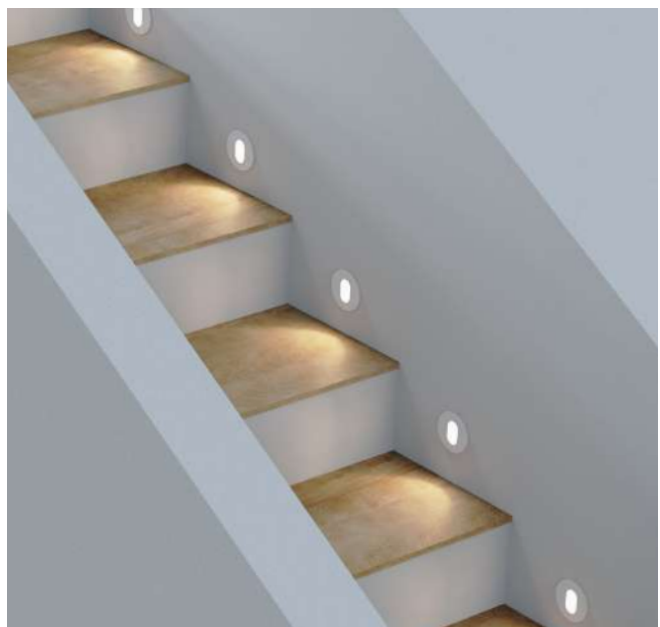

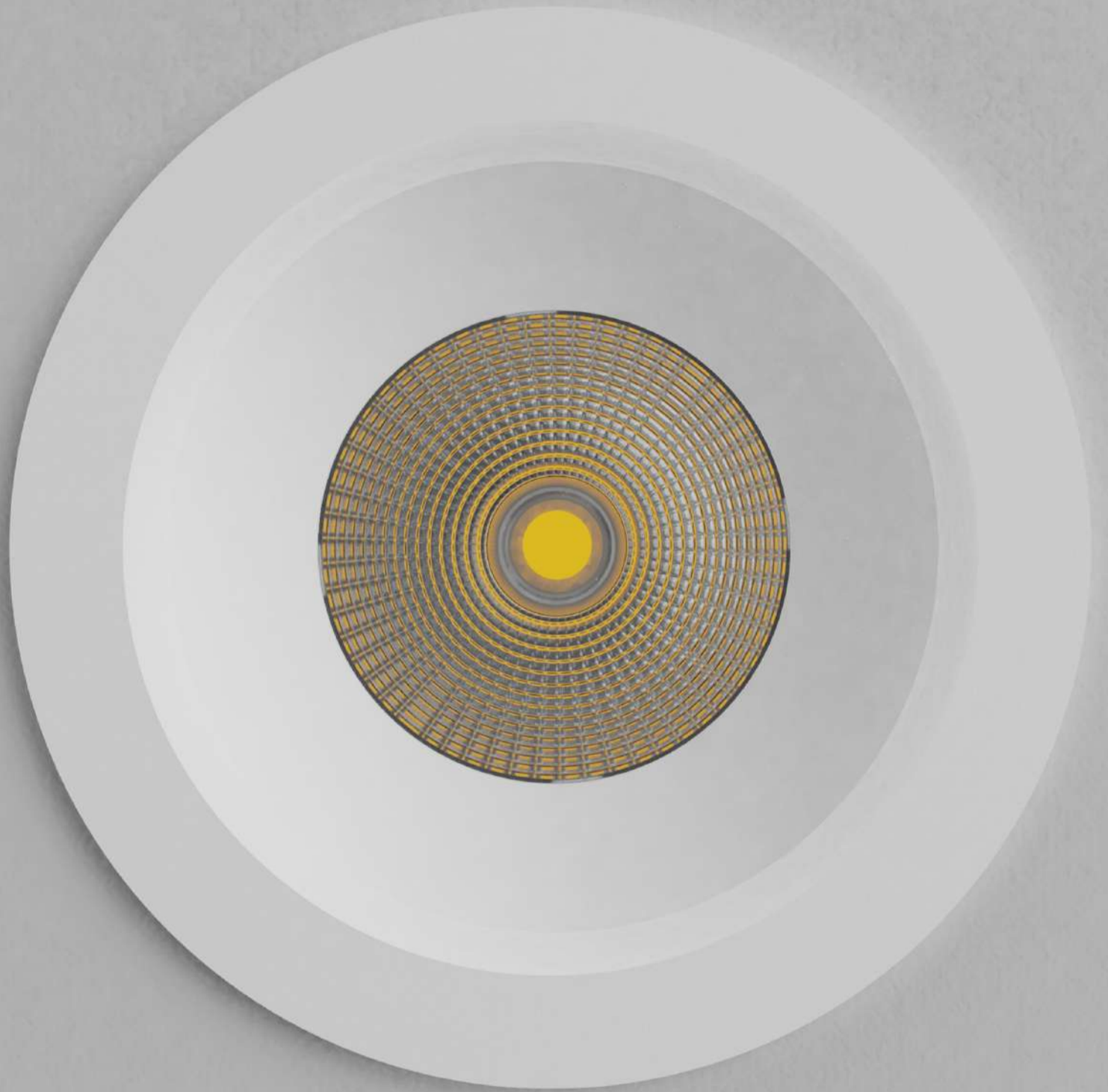



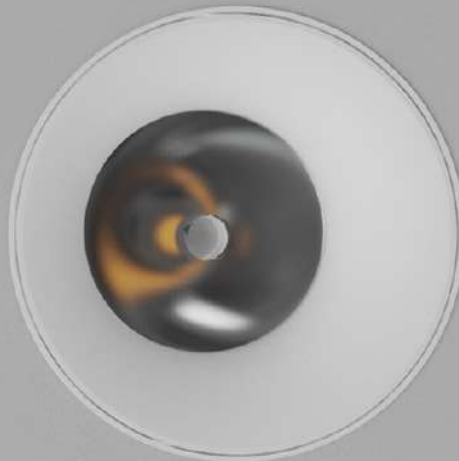



DOTFIX



by
REGINA
SCHULLER

DOTFIX

EMPOTRABLES

LED COB AC 220-240V 50-60Hz

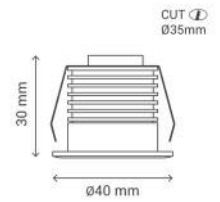

Material 

105033	3 W	150 lm	2700 K	15°	Blanco RAL 9003
105052	3 W	150 lm	2700 K	24°	Blanco RAL 9003
105053	3 W	150 lm	2700 K	45°	Blanco RAL 9003
105054	3 W	150 lm	2700 K	15°	Negro RAL 9005
105055	3 W	150 lm	2700 K	24°	Negro RAL 9005
105056	3 W	150 lm	2700 K	45°	Negro RAL 9005
105043	3 W	150 lm	4000 K	15°	Blanco RAL 9003
105057	3 W	150 lm	4000 K	24°	Blanco RAL 9003
105058	3 W	150 lm	4000 K	45°	Blanco RAL 9003
105059	3 W	150 lm	4000 K	15°	Negro RAL 9005
105061	3 W	150 lm	4000 K	24°	Negro RAL 9005
105062	3 W	150 lm	4000 K	45°	Negro RAL 9005



IP

20

 -10~
+40°C



CRI90



30000



50000 h

REF/105033

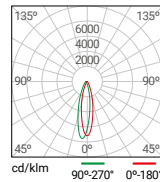

DOTFIX

EMPOTRABLES

LED COB AC 220-240V 50-60Hz

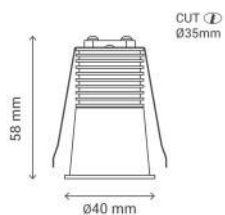

Material **A**

105032	5 W	250 lm	2700 K	15°	Blanco RAL 9003
105047	5 W	250 lm	2700 K	45°	Blanco RAL 9003
105046	5 W	250 lm	2700 K	15°	Negro RAL 9005
105048	5 W	250 lm	2700 K	45°	Negro RAL 9005
105042	5 W	250 lm	4000 K	15°	Blanco RAL 9003
105050	5 W	250 lm	4000 K	45°	Blanco RAL 9003
105049	5 W	250 lm	4000 K	15°	Negro RAL 9005
105051	5 W	250 lm	4000 K	45°	Negro RAL 9005



REF/105032

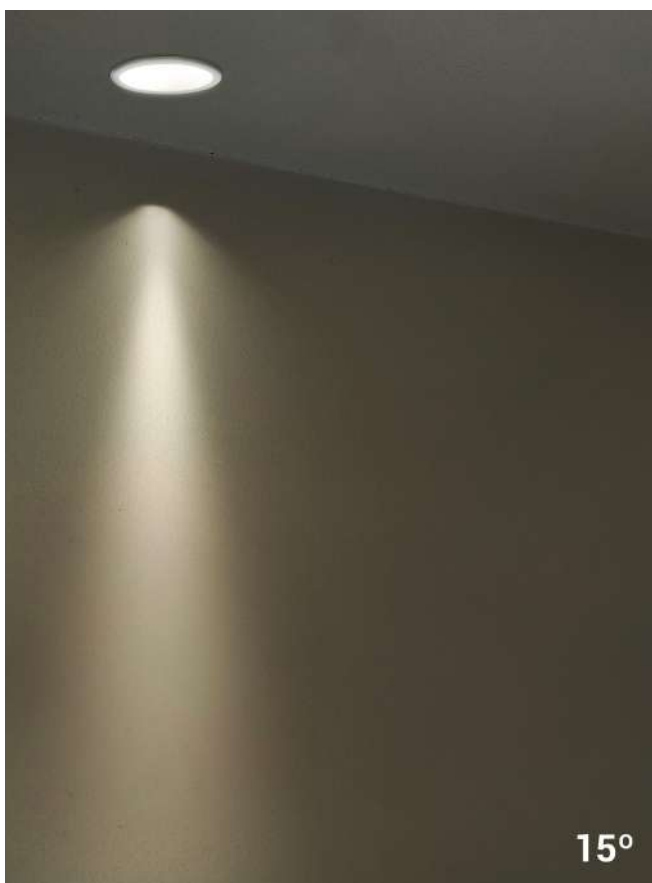
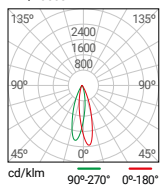

15°

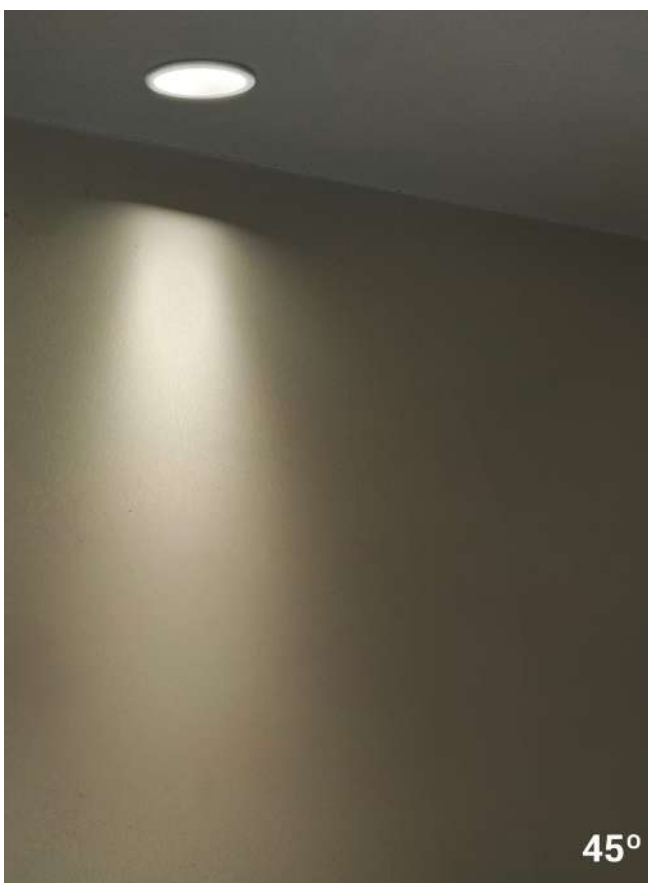

45°

DOTFIX

EMPOTRABLES

LED COB AC 220-240 V 50-60 Hz

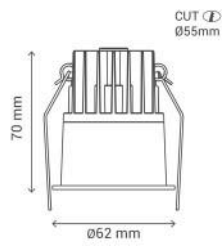

Material

105022	8 W	400 lm	2700-4000-6000 K	15°	Blanco RAL 9003
105063	8 W	400 lm	2700-4000-6000 K	36°	Blanco RAL 9003
105064	8 W	400 lm	2700-4000-6000 K	15°	Negro RAL 9005
105065	8 W	400 lm	2700-4000-6000 K	36°	Negro RAL 9005



IP
20

°C -10~
+40°C



30000

50000 h

Antes de la instalación
Before installation

REF/105022

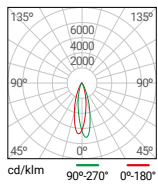

DOTFIX

EMPOTRABLES

LED COB AC 220-240 V 50-60 Hz

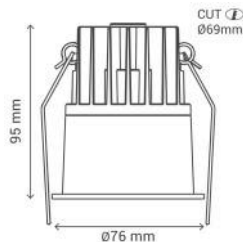

Material

105025	15 W	900 lm	2700-4000-6000 K	15°	Blanco RAL 9003
105066	15 W	900 lm	2700-4000-6000 K	36°	Blanco RAL 9003
105067	15 W	900 lm	2700-4000-6000 K	15°	Negro RAL 9005
105068	15 W	900 lm	2700-4000-6000 K	36°	Negro RAL 9005



IP
20

°C -10~
+40°C



30000

50000 h

Antes de la instalación
Before installation

REF/105025

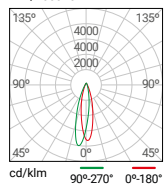

DOTFIX

EMPOTRABLES

LED COB AC 220-240V 50-60Hz

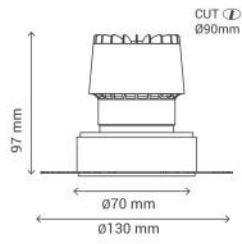

Material

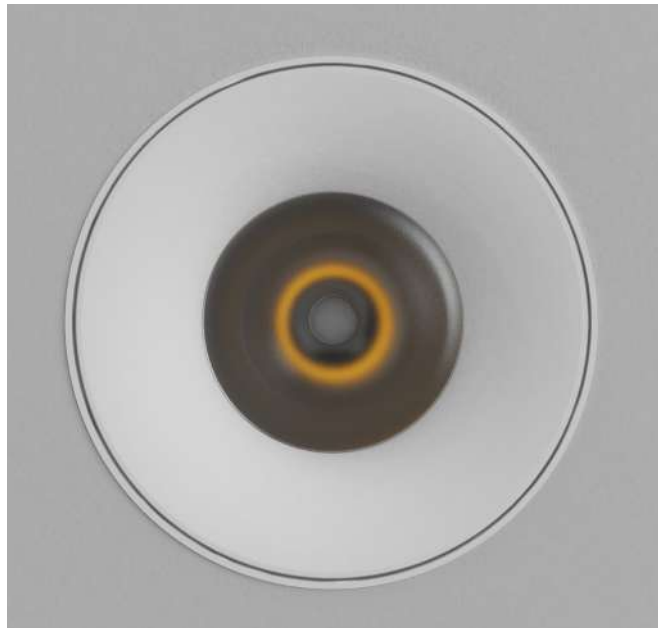

105031	15 W	900 lm	2700-4000-6000 K	15°	Blanco RAL 9003
105069	15 W	900 lm	2700-4000-6000 K	36°	Blanco RAL 9003



IP 20

U_E -10~ +40°C



Antes de la instalación
Before installation



REF/105031

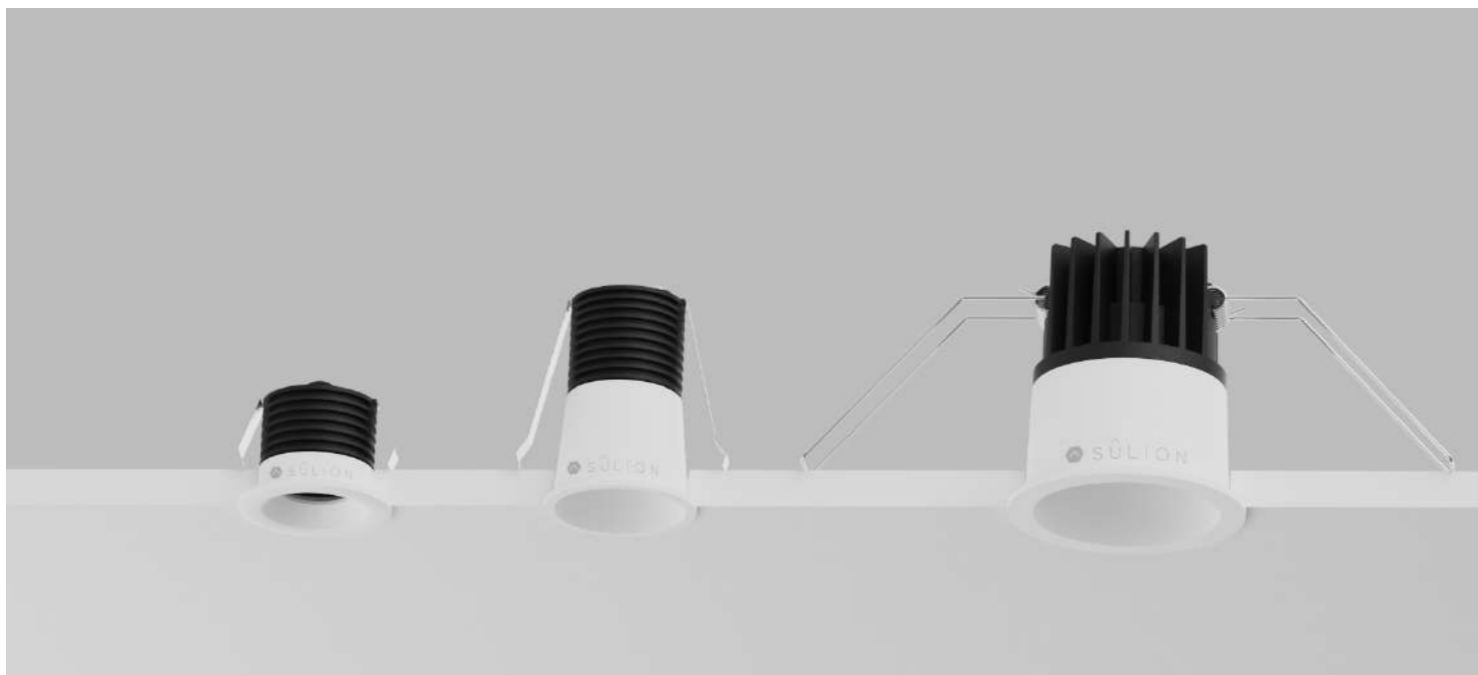
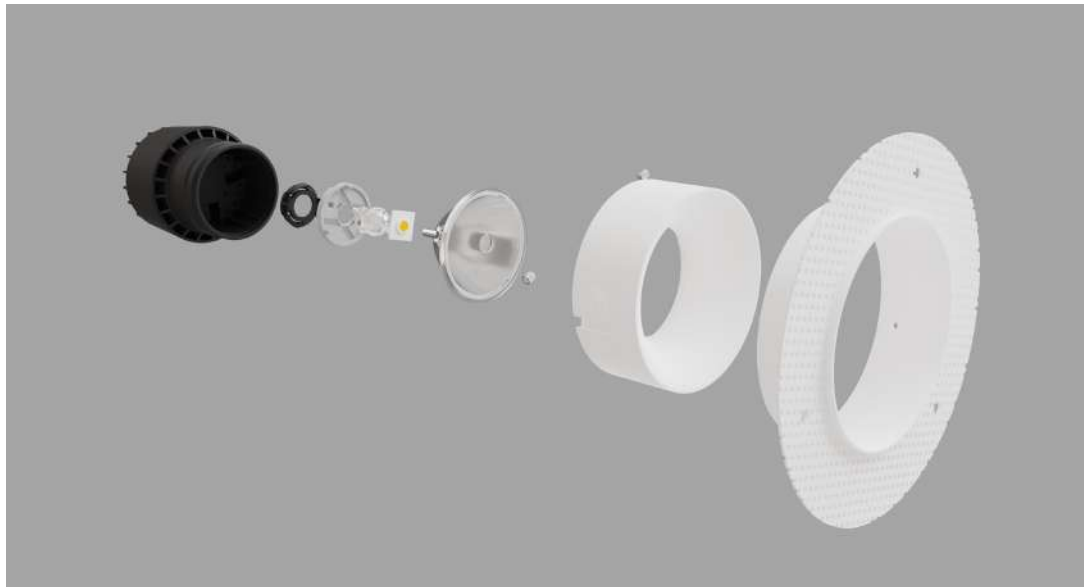
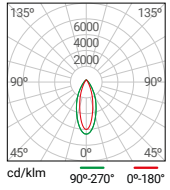

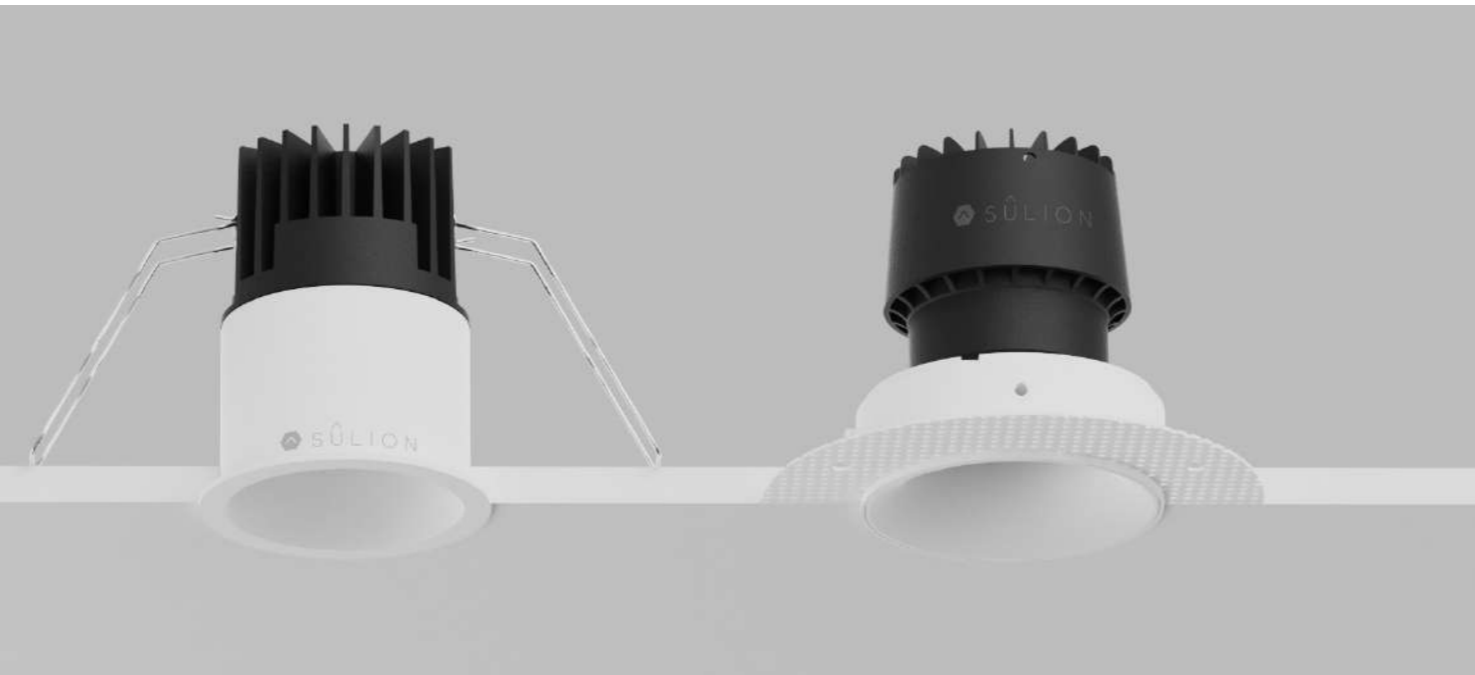

ARUMFIX



ARUMFIX

EMPOTRABLES

LED COB AC 100-240V 50-60Hz

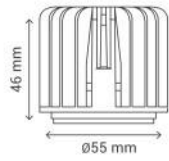

Material

111077 9 W 500 lm 3000 K Negro RAL 9005

ARUMFIX

EMPOTRABLES

LED COB AC 100-240V 50-60Hz

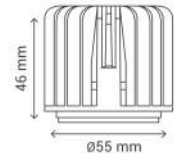

Material

111078 9 W 500 lm 3000 K Negro RAL 9005



ARUMFIX

EMPOTRABLES

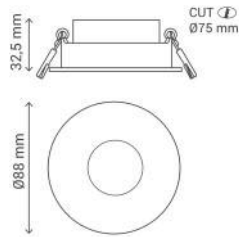

Material

111031 Blanco RAL 9003



ARUMFIX

EMPOTRABLES

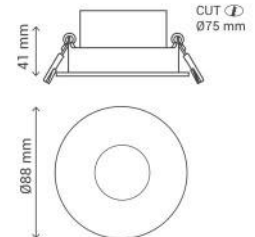

Material

111029 Blanco RAL 9003

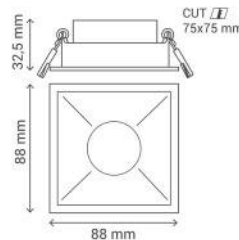

Material

111032 Blanco RAL 9003

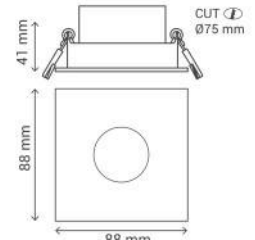

Material

111030 Blanco RAL 9003



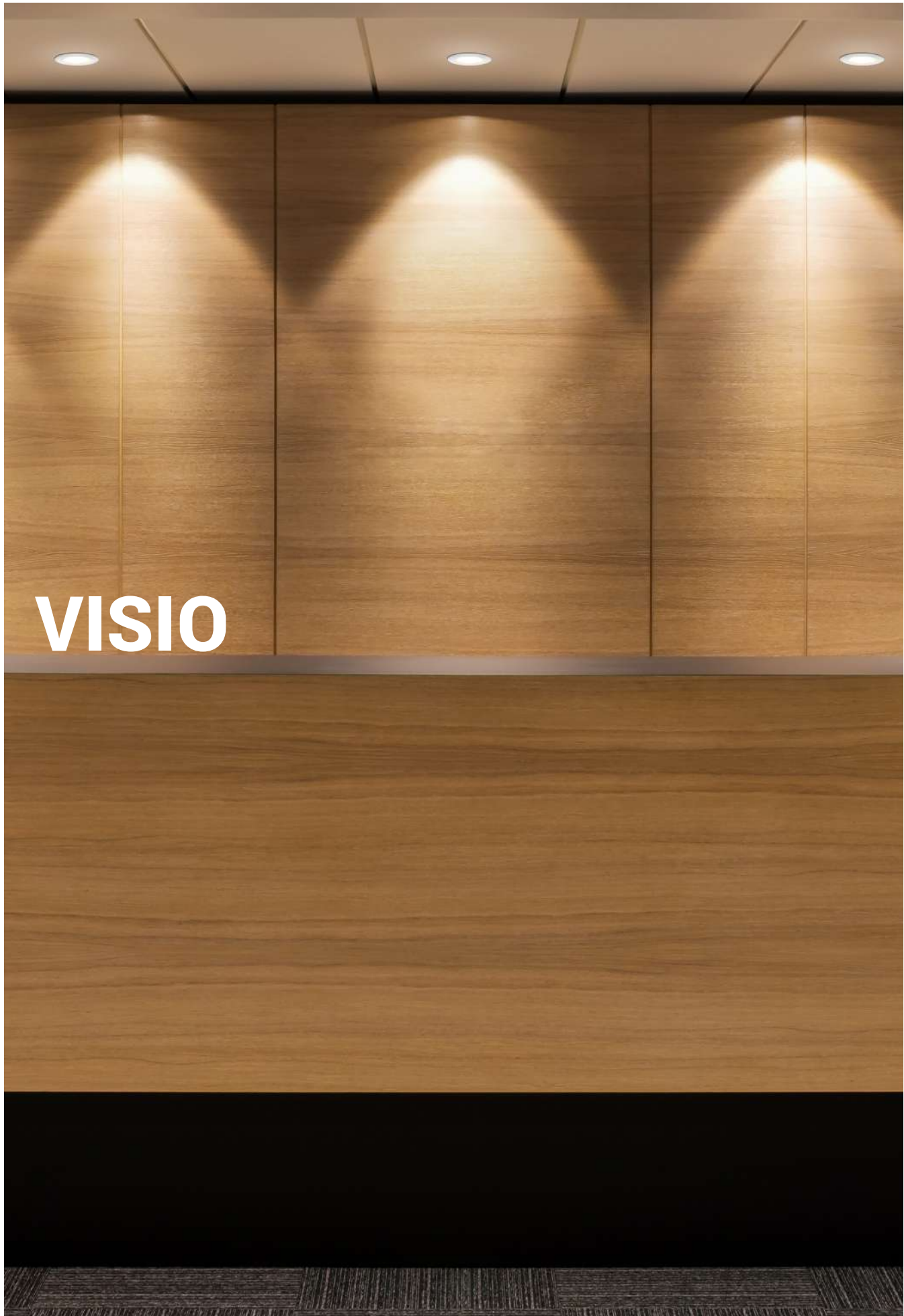

VISIO

VISIO

EMPOTRABLES

LED COB AC 100-240V 50-60Hz

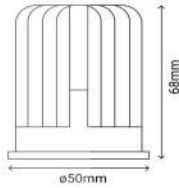

Material **M**

101630	11 W	950 lm	2700-4000-5500 K	24°	Negro RAL 9005
101631	11 W	950 lm	2700-4000-5500 K	60°	Negro RAL 9005
101602	11 W	950 lm	2700-4000-5500 K	120°	Negro RAL 9005



IP 20

°C -20~ +50°C



10000

35000 h



Antes de la instalación
Before installation

Accesorios / Accessories

25153 - Driver 12W

25152 - Driver 12W WiFi



VISIO

EMPOTRABLES

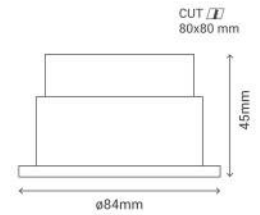

Material **ABS**

101621 1 xGU10 Blanco RAL 9003



COMPATIBLE CON MÓDULO LED VISIO

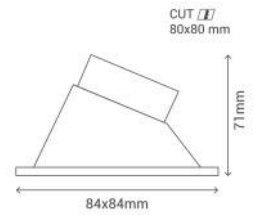

Material **ABS**

101624 1 xGU10 Blanco RAL 9003



COMPATIBLE CON MÓDULO LED VISIO

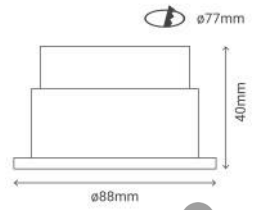

Material **ABS**

101618 1 xGU10 Blanco RAL 9003



COMPATIBLE CON MÓDULO LED VISIO

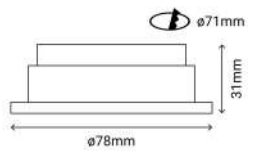

Material **ABS**

101606 1 xGU10 Blanco RAL 9003



25°



COMPATIBLE CON MÓDULO LED VISIO

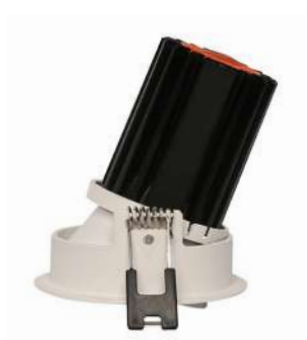



SAND

EMPOTRABLES



Material

101178	1 xGU10	Blanco RAL 9003
101179	1 xGU10	Níquel



COMPATIBLE CON MÓDULO LED VISIO - PAG 25

SAND

EMPOTRABLES



Material

101180	1 xGU10	Blanco RAL 9003
101181	1 xGU10	Níquel



COMPATIBLE CON MÓDULO LED VISIO - PAG 25



ARC

EMPOTRABLES

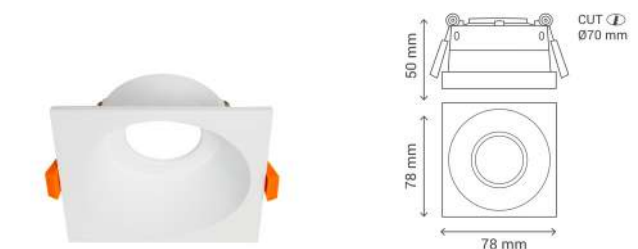

Material

112368	1 xGU10	Blanco RAL 9003
---------------	---------	-----------------



COMPATIBLE CON MÓDULO LED VISIO - PAG 25

ARC

EMPOTRABLES



Material

112364	1 xGU10	Blanco RAL 9003
---------------	---------	-----------------



COMPATIBLE CON MÓDULO LED VISIO - PAG 25



DUCK



REF/101254

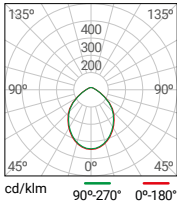

DUCK **EMPOTRABLES**

LED COB AC 220-240 V 50-60 Hz



101254	7 W	550 lm	3000 K	Blanco RAL 9003
101250	7 W	570 lm	4000 K	Blanco RAL 9003

- Triac
- 38°
- IP 20
- 20~+50°C
- 10000
- 35000 h
- 25°
- DIM +
- CRI80



TURK



TURK

EMPOTRABLES

LED SMD AC 100-265 V 50-60 Hz

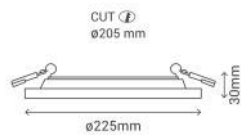

Material **AC** **PC**

101265	20 W	2200 lm	4000 K	Blanco RAL 9003
101266	20 W	2150 lm	3000 K	Blanco RAL 9003

TURK

EMPOTRABLES

LED SMD AC 100-265 V 50-60 Hz

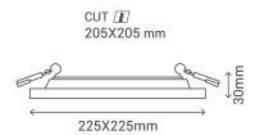

Material **AC** **PC**

102265	20 W	2200 lm	4000 K	Blanco RAL 9003
102266	20 W	2150 lm	3000 K	Blanco RAL 9003



BUGY

EMPOTRABLES

LED SMD AC 220-240 V 50-60 Hz

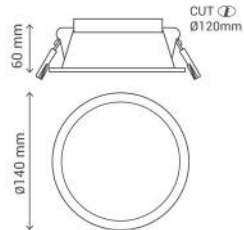

Material

101175	15 W	1200 lm	3000 K	Blanco RAL 9003
101176	15 W	1250 lm	4000 K	Blanco RAL 9003

BUGY

EMPOTRABLES

LED SMD AC 220-240 V 50-60 Hz

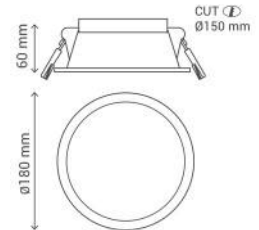

Material

101173	20 W	1600 lm	3000 K	Blanco RAL 9003
101174	20 W	1650 lm	4000 K	Blanco RAL 9003



Triac
CRI80

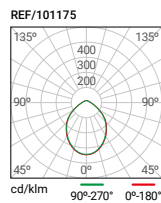

Triac
CRI80

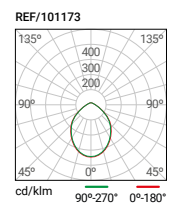



BUGY

EMPOTRABLES

LED SMD AC 220-240V 50-60Hz

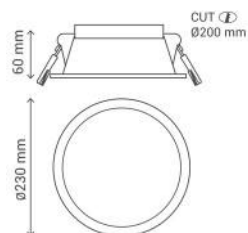

Material **A** **PC**

101149	25 W	2150 lm	4000 K	Blanco RAL 9003
101172	25 W	2100 lm	3000 K	Blanco RAL 9003













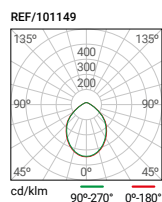



THOR

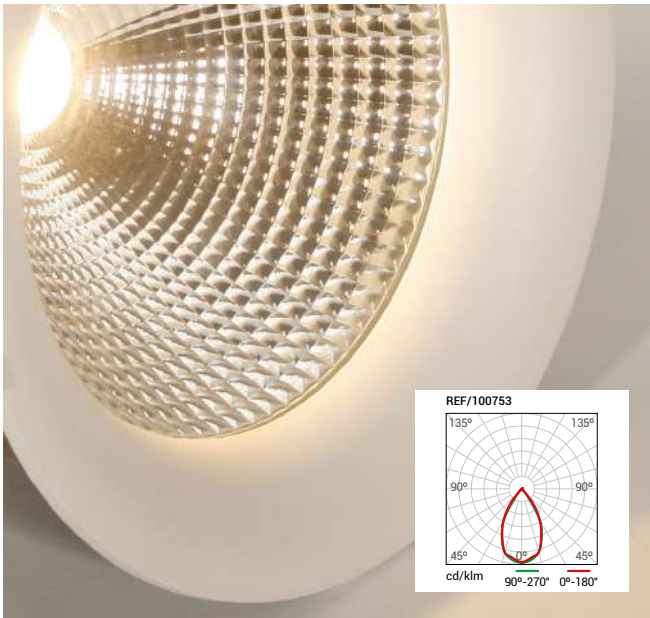

THOR

EMPOTRABLES

LED COB AC 220-240V 50-60 Hz

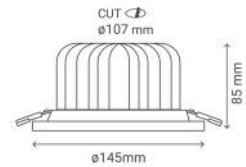

Material

101753	20 W	1800 lm	3000 K	Blanco RAL 9003
101759	20 W	1850 lm	4000 K	Blanco RAL 9003

IP 20 -20~+50°C **UGR <19**
 100° 10000 35000 h - DIM +

THOR

EMPOTRABLES

LED COB AC 220-240V 50-60 Hz

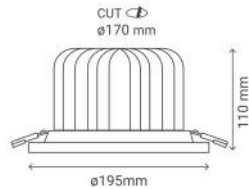

Material

100752	40 W	3650 lm	4000 K	Blanco RAL 9003
100760	40 W	3500 lm	3000 K	Blanco RAL 9003

IP 20 -20~+50°C **UGR <19**
 100° 10000 35000 h - DIM +

THOR

EMPOTRABLES

LED COB AC 220-240V 50-60 Hz

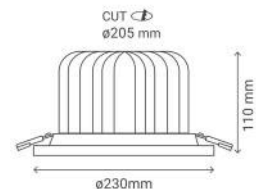

Material

100753	60 W	5450 lm	4000 K	Blanco RAL 9003
100759	60 W	5400 lm	3000 K	Blanco RAL 9003

IP 20 -20~+50°C **UGR <19**
 100° 10000 35000 h - DIM +



HOLEGLAS

EMPOTRABLES

LED SMD AC 85-265 V 50-60 Hz



Material A V

101060 6 W 390 lm 4000 K Blanco RAL 9003



HOLEGLAS

EMPOTRABLES

LED SMD AC 85-265 V 50-60 Hz



Material A V

101061 12 W 890 lm 4000 K Blanco RAL 9003

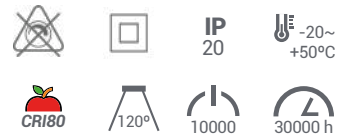

HOLEGLAS

EMPOTRABLES

LED SMD AC 85-265 V 50-60 Hz



Material A V

101062 18 W 1600 lm 4000 K Blanco RAL 9003

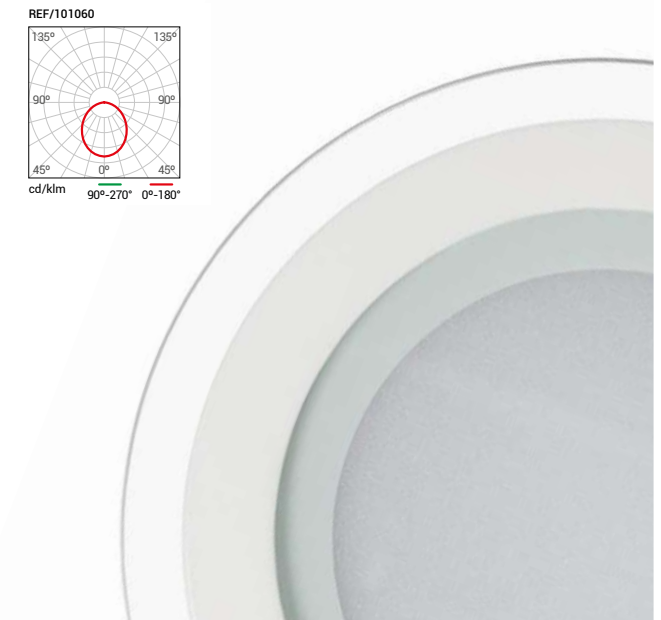
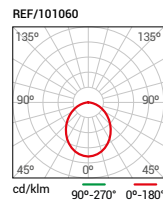

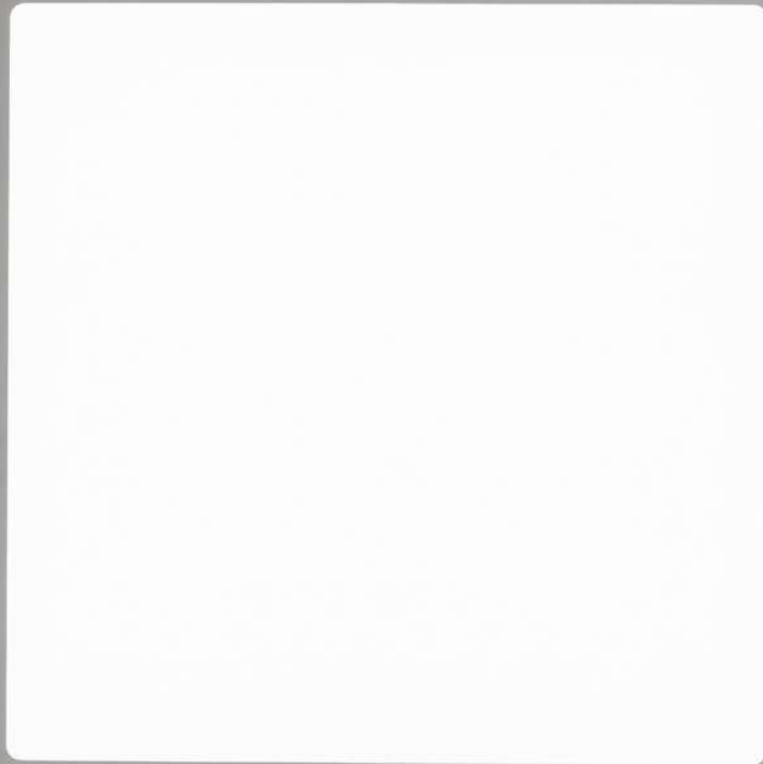
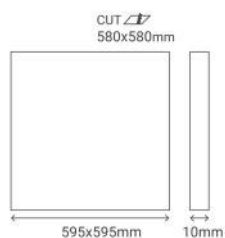

PLATE / TAPE

TAPE

LED SMD AC 200-240 V 50-60 Hz

EMPOTRABLES



Material **ABS** **M**

112168	45 W	5400 lm	4000 K	Blanco RAL 9003
112968	45 W	5500 lm	5000 K	Blanco RAL 9003



PLATE

EMPOTRABLES

LED SMD AC 85-265V 50-60Hz

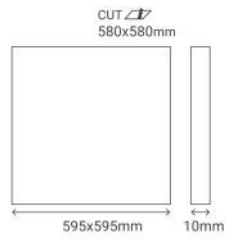

Material

100846 40 W 3200 lm 4000 K Blanco RAL 9003

IP 20
 -20~+50°C

 120°
 10000
 30000 h

UGR <19

Accesorios / Accessories

50623 - Marco superficie

PLATE

EMPOTRABLES

LED SMD 24VDC

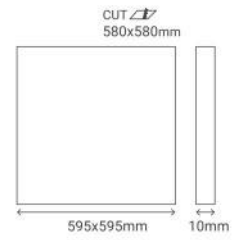

Material

101056 36 W RGB Blanco RAL 9003

IP 20
 -20~+50°C
 120°
 10000
 30000 h

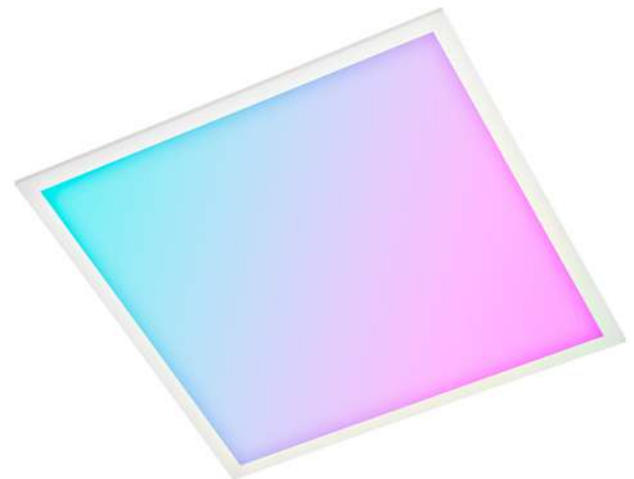

PLATE

EMPOTRABLES

LED SMD AC 100-240V 50-60Hz

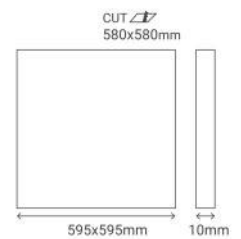

Material

113150 40 W 3200 lm 3000-6500 K Blanco RAL 9003

IP 20
 -20~+50°C

 120°
 10000
 25000 h

PEAK





LED DE ALTA EFICIENCIA



PEAK

EMPOTRABLES

LED SMD AC 220-240V 50-60 Hz

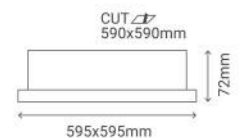

Material **M** **PC**

100832 34 W 3300 lm 4000 K Blanco RAL 9003

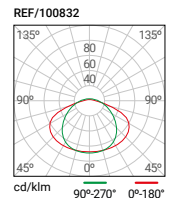

Accesorios / Accessories

- 50627 - Marco superficie
- 50629 - Kit emergencia

PEAK

EMPOTRABLES

LED SMD AC 220-240V 50-60 Hz

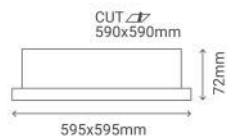

Material **M** **PC**

100834 36 W 4190 lm 4000 K Blanco RAL 9003

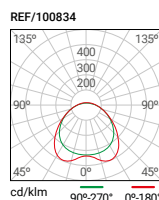

Accesorios / Accessories

- 50627 - Marco superficie
- 50629 - Kit emergencia

PEAK

EMPOTRABLES

LED SMD AC 220-240V 50-60 Hz

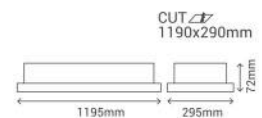

Material **M** **PC**

100836 34 W 3300 lm 4000 K Blanco RAL 9003

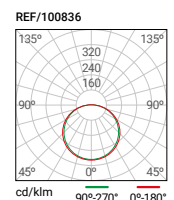

Accesorios / Accessories

- 50628 - Marco superficie
- 50629 - Kit emergencia

FRONT



FRONT

EMPOTRABLES

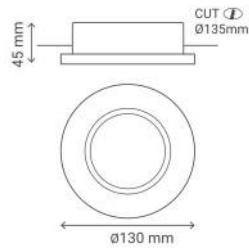

Material **Y**

101151 1 xGU10 Blanco



FRONT

EMPOTRABLES

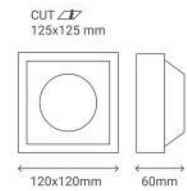

Material **Y**

102155 1 xGU10 Blanco



FRONT

EMPOTRABLES

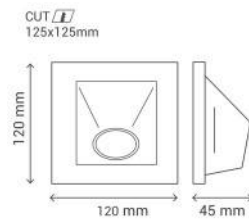

Material **Y**

101156 1 xGU10 Blanco



FRONT

EMPOTRABLES

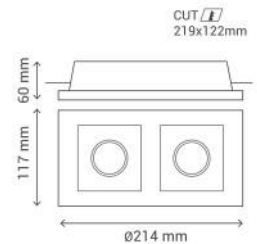

Material **Y**

101153 2 xGU10 Blanco



FRONT

EMPOTRABLES

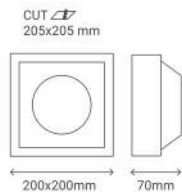

Material **Y**

102152 1 xAR111 Blanco



FRONT

EMPOTRABLES

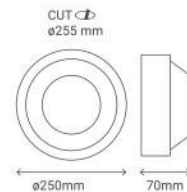

Material **Y**

102151 1 xAR111 Blanco



FRONT

EMPOTRABLES

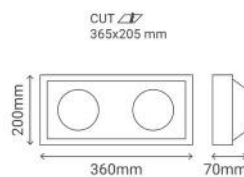

Material **Y**

102153 2 xAR111 Blanco

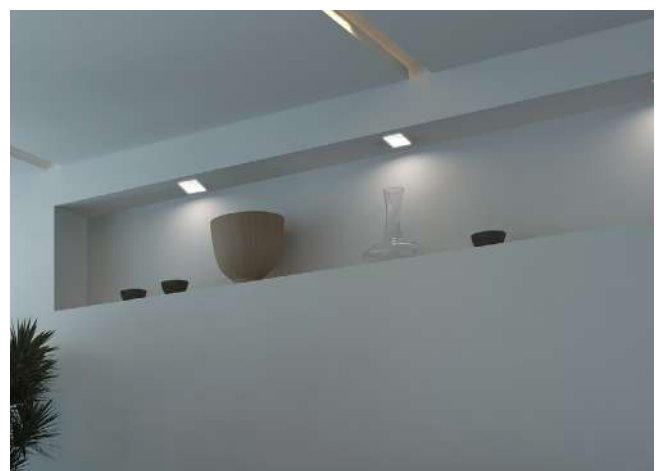





A modern staircase with light wood treads and white risers, featuring a white handrail and recessed circular lights in the wall. The word "BELY" is overlaid on the image.

BELY



BELY

BAÑADORES

LED COB AC 100-240V 50-60Hz

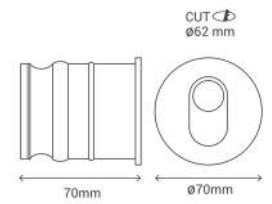

Material 

400090	3 W	120 lm	3000 K	Blanco RAL 9003
400110	3 W	120 lm	3000 K	Gris antracita RAL 7012
400112	3 W	120 lm	3000 K	Marrón RAL 8025
400089	3 W	120 lm	4000 K	Blanco RAL 9003
400111	3 W	120 lm	4000 K	Gris antracita RAL 7012
400113	3 W	120 lm	4000 K	Marrón RAL 8025



IP
54

U_e -20~
+50°C



L
15000

L
25000 h

REF/400090

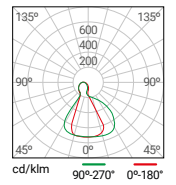

BELY

BAÑADORES

LED COB AC 100-240V 50-60Hz

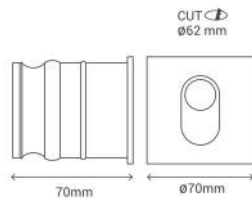

Material 

400114	3 W	120 lm	3000 K	Blanco RAL 9003
400116	3 W	120 lm	3000 K	Gris antracita RAL 7012
400118	3 W	120 lm	3000 K	Marrón RAL 8025
400115	3 W	120 lm	4000 K	Blanco RAL 9003
400117	3 W	120 lm	4000 K	Gris antracita RAL 7012
400119	3 W	120 lm	4000 K	Marrón RAL 8025



IP
54

U_e -20~
+50°C



L
15000

L
25000 h

REF/400114

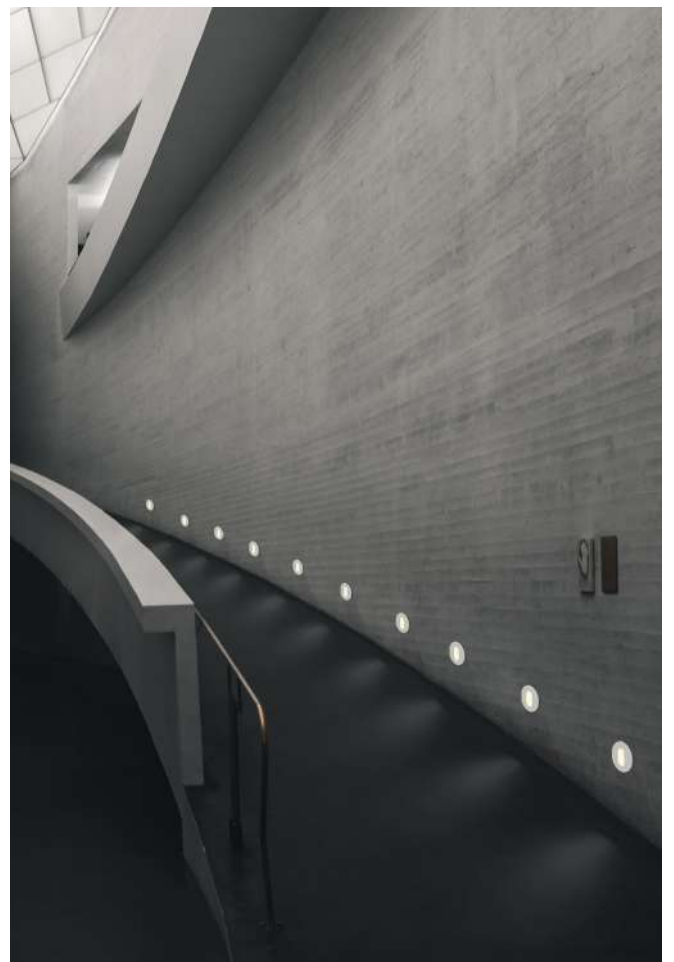
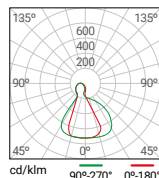

A photograph showing a close-up of a dark brown wooden floor with a prominent grain pattern. The floor is set against a white, curved wall. Two recessed lighting fixtures are visible, casting a warm, yellowish glow onto the wood. The lighting creates a soft, ambient atmosphere. The word "MARTÍN" is overlaid in white, bold, sans-serif capital letters on the left side of the image.

MARTÍN



MARTÍN

BAÑADORES

SMD AC 220-240V 50-60Hz



CUT 75x175 mm

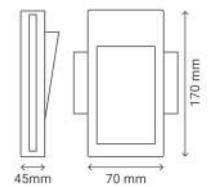

Material **Y**

111634	2 W	160 lm	2700 K	Blanco RAL 9003
111635	2 W	180 lm	4000 K	Blanco RAL 9003



IP 20

-5~ +40°C



60°

10000

15000 h



MARTÍN

BAÑADORES

SMD AC 220-240V 50-60Hz



CUT 145x175 mm

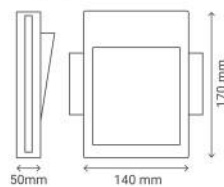

Material **Y**

111638	2 W	160 lm	2700 K	Blanco RAL 9003
111639	2 W	180 lm	4000 K	Blanco RAL 9003



IP 20

-5~ +40°C



60°

10000

15000 h



MARTÍN

BAÑADORES

SMD AC 220-240V 50-60Hz



CUT 120x255 mm

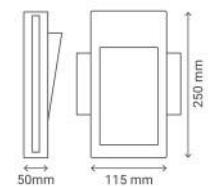

Material **Y**

111636	2 W	160 lm	2700 K	Blanco RAL 9003
111637	2 W	180 lm	4000 K	Blanco RAL 9003



IP 20

-5~ +40°C



60°

10000

15000 h



ASTON / RAYFIX / LINDEFIX



ASTON

BAÑADORES

COB AC 220-240V 50-60 Hz

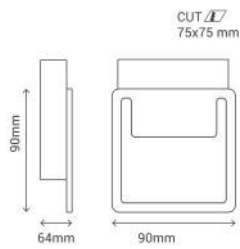

Material

111090 3,5 W 160 lm 3000 K Blanco RAL 9003

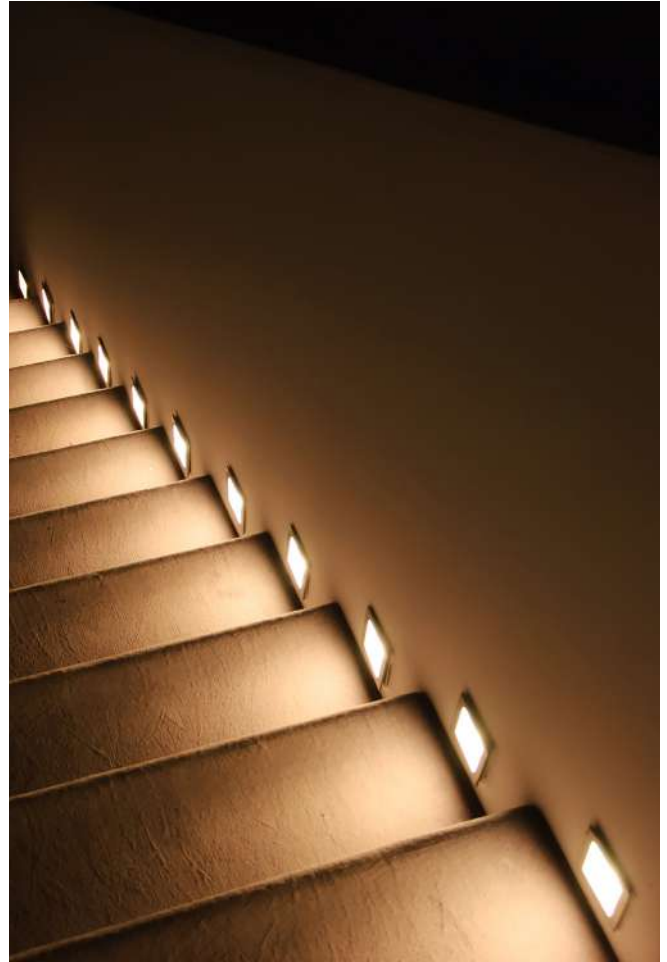

RAYFIX

BAÑADORES

COB AC 110-240V 50-60 Hz

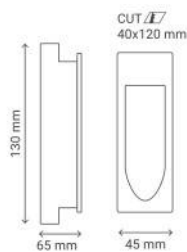

Material

111042 3 W 100 lm 3000 K Blanco RAL 9003



LINDENFIX

BAÑADORES

COB AC 110-240V 50-60 Hz

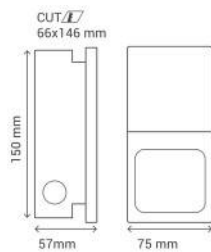

Material

111041 3 W 100 lm 3000 K Blanco RAL 9003









LINHA

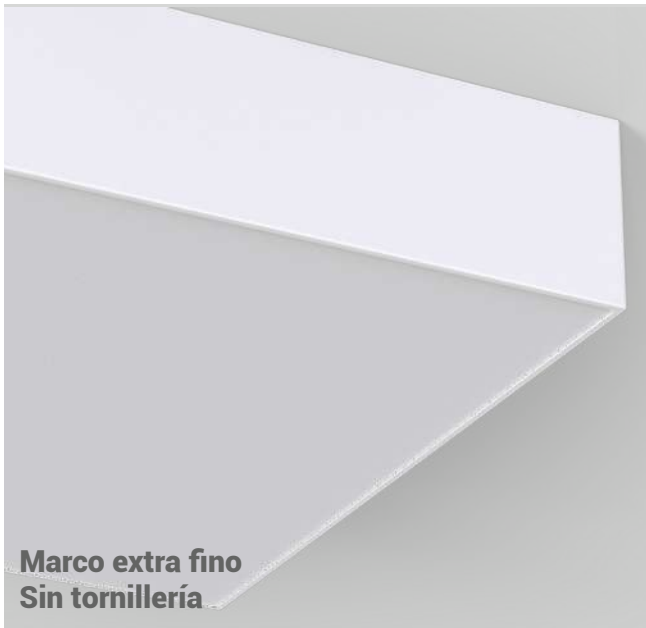

LINHA PLAFONES

LED SMD AC 220-240V 50-60Hz

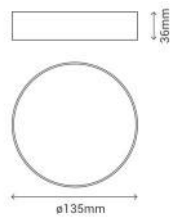

Material **ABS**

103415 12 W 1080 lm 3000-4000-5500 K Blanco RAL 9003



LINHA PLAFONES

LED SMD AC 220-240V 50-60Hz

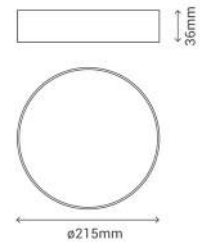

Material **ABS**

103416 24 W 2160 lm 3000-4000-5500 K Blanco RAL 9003

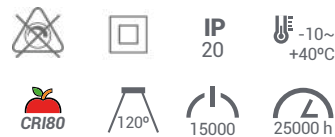

LINHA PLAFONES

LED SMD AC 220-240V 50-60Hz

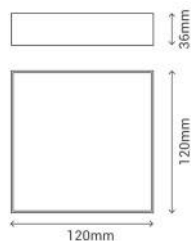

Material **ABS**

103417 12 W 1080 lm 3000-4000-5500 K Blanco RAL 9003



LINHA PLAFONES

LED SMD AC 220-240V 50-60Hz

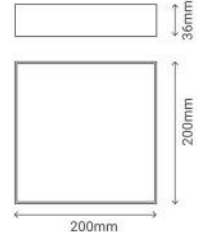

Material **ABS**

103418 24 W 2160 lm 3000-4000-5500 K Blanco RAL 9003





ALPHA

PLAFONES

COB AC 90-250V 50-60Hz

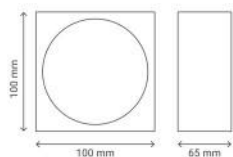

Material 

100819

7 W

600 lm

4000 K

Blanco RAL 9003

ALPHA

PLAFONES

COB AC 90-250V 50-60Hz

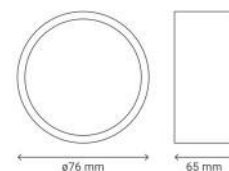

Material 

100818

7 W

600 lm

4000 K

Blanco RAL 9003





CIFO

PLAFONES

LED SMD AC 220-240V 50-60Hz

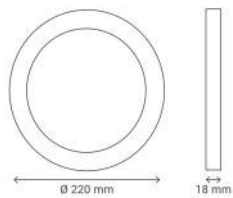

Material **A** **PC**

111770 20 W 1500 lm 4000 K Blanco RAL 9003

CIFO

PLAFONES

LED SMD AC 220-240V 50-60Hz

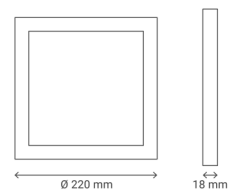

Material **A** **PC**

100770 20 W 1500 lm 4000 K Blanco RAL 9003



by
REGINA
SCHULLER

KIRA



KIRA

PLAFONES

LED COB AC 220-240V 50-60Hz



Material



105030	12 W	700 lm	2700-4000-6000 K	15°	Blanco RAL 9003
105070	12 W	700 lm	2700-4000-6000 K	36°	Blanco RAL 9003
105040	12 W	700 lm	2700-4000-6000 K	15°	Negro RAL 9005
105077	12 W	700 lm	2700-4000-6000 K	36°	Negro RAL 9005
105071	12 W	700 lm	2700-4000-6000 K	15°	Blanco RAL 9003 / Latón RAL 9032
105072	12 W	700 lm	2700-4000-6000 K	36°	Blanco RAL 9003 / Latón RAL 9032
105078	12 W	700 lm	2700-4000-6000 K	15°	Negro RAL 9005 / Latón RAL 9032
105079	12 W	700 lm	2700-4000-6000 K	36°	Negro RAL 9005 / Latón RAL 9032



IP 20

°C -10~ +40°C



Antes de la instalación
Before installation

REF/105030

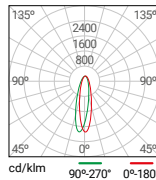

KIRA

PLAFONES

LED COB AC 220-240V 50-60Hz



Material



105035	20 W	1000 lm	2700-4000-6000 K	15°	Blanco RAL 9003
105084	20 W	1000 lm	2700-4000-6000 K	36°	Blanco RAL 9003
105045	20 W	1000 lm	2700-4000-6000 K	15°	Negro RAL 9005
105091	20 W	1000 lm	2700-4000-6000 K	36°	Negro RAL 9005
105085	20 W	1000 lm	2700-4000-6000 K	15°	Blanco RAL 9003 / Latón RAL 9032
105086	20 W	1000 lm	2700-4000-6000 K	36°	Blanco RAL 9003 / Latón RAL 9032
105092	20 W	1000 lm	2700-4000-6000 K	15°	Negro RAL 9005 / Latón RAL 9032
105093	20 W	1000 lm	2700-4000-6000 K	36°	Negro RAL 9005 / Latón RAL 9032



IP 20

°C -10~ +40°C



Antes de la instalación
Before installation

REF/105035

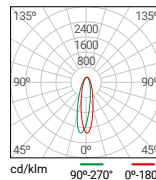

KIRA

COLGANTES

LED COB AC 220-240 V 50-60 Hz

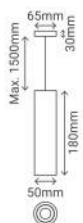

Material 

105073	12 W	700 lm	2700-4000-6000 K	15°	Blanco RAL 9003
105074	12 W	700 lm	2700-4000-6000 K	36°	Blanco RAL 9003
105080	12 W	700 lm	2700-4000-6000 K	15°	Negro RAL 9005
105081	12 W	700 lm	2700-4000-6000 K	36°	Negro RAL 9005
105075	12 W	700 lm	2700-4000-6000 K	15°	Blanco RAL 9003 / Latón RAL 9032
105076	12 W	700 lm	2700-4000-6000 K	36°	Blanco RAL 9003 / Latón RAL 9032
105082	12 W	700 lm	2700-4000-6000 K	15°	Negro RAL 9005 / Latón RAL 9032
105083	12 W	700 lm	2700-4000-6000 K	36°	Negro RAL 9005 / Latón RAL 9032

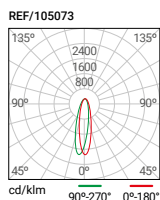

KIRA

LED COB AC 220-240V 50-60Hz

COLGANTES

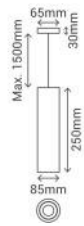

Material 

105087	20 W	1000 lm	2700-4000-6000 K	15°	Blanco RAL 9003
105088	20 W	1000 lm	2700-4000-6000 K	36°	Blanco RAL 9003
105094	20 W	1000 lm	2700-4000-6000 K	15°	Negro RAL 9005
105095	20 W	1000 lm	2700-4000-6000 K	36°	Negro RAL 9005
105089	20 W	1000 lm	2700-4000-6000 K	15°	Blanco RAL 9003 / Latón RAL 9032
105090	20 W	1000 lm	2700-4000-6000 K	36°	Blanco RAL 9003 / Latón RAL 9032
105096	20 W	1000 lm	2700-4000-6000 K	15°	Negro RAL 9005 / Latón RAL 9032
105097	20 W	1000 lm	2700-4000-6000 K	36°	Negro RAL 9005 / Latón RAL 9032



IP

20 



CR190



30000



50000 h



3CCT Antes de la instalación
SWICHT Before installation

REF/105087

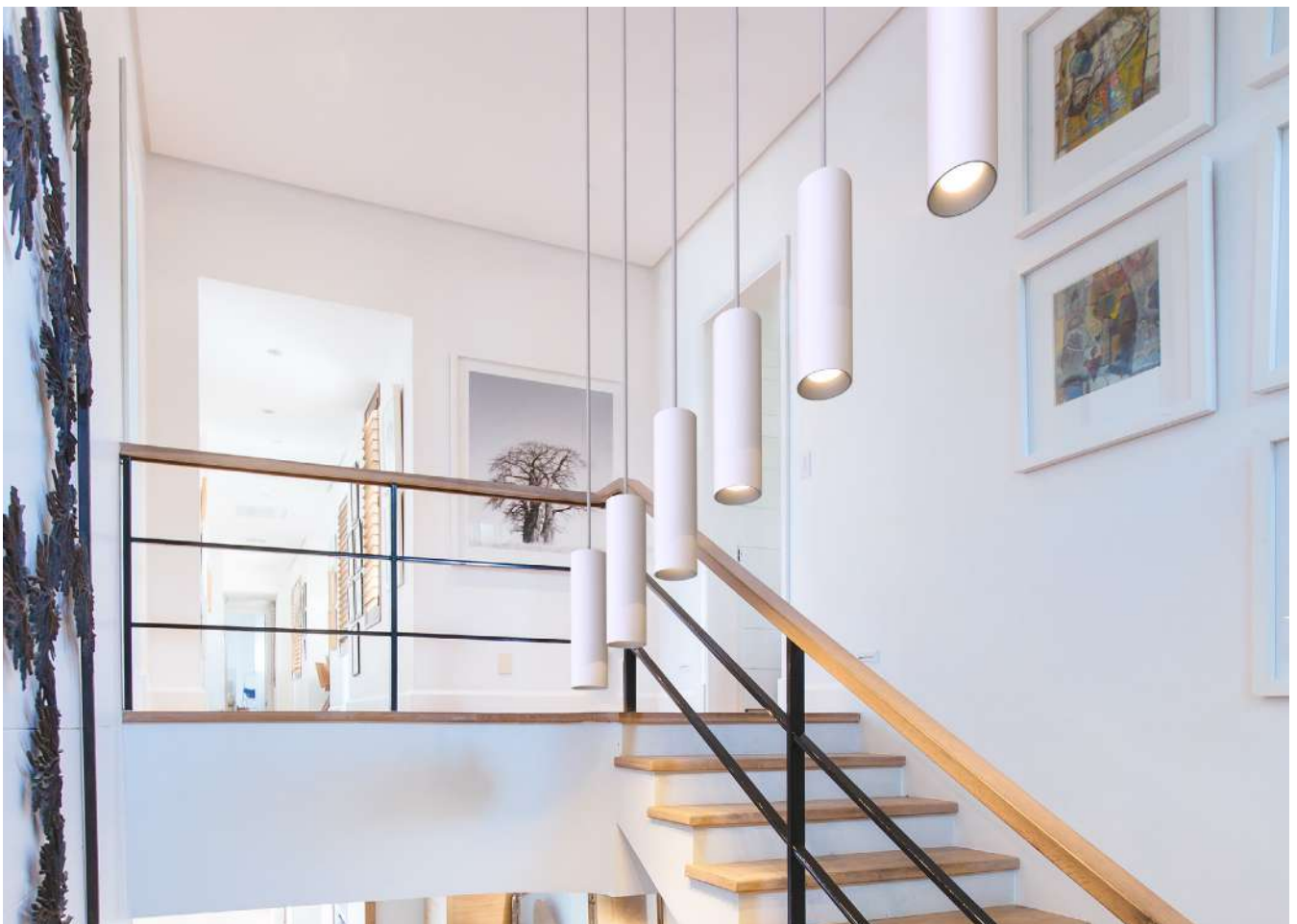
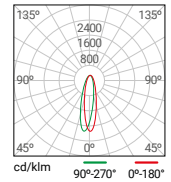



CARMEN



by
REGINA
SCHULLER



VALENTINA



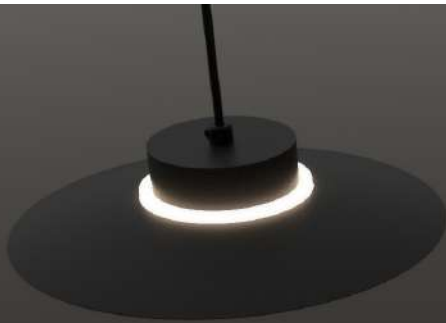

CARMEN



VALENTINA





DOS MÓDULOS LED
CON INFINITAS POSIBILIDADES



CARMEN

COLGANTES

LED SMD AC 220-240V 50-60Hz



200994



200987

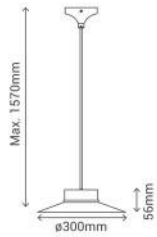

200986



200995

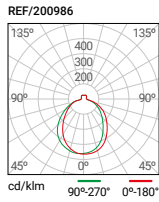

CARMEN

COLGANTES

LED SMD AC 220-240V 50-60Hz



200996



200989

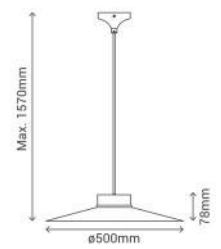

200988



200997

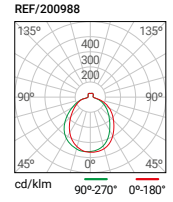

CARMEN

COLGANTES

LED SMD AC 220-240V 50-60Hz



200999



200990

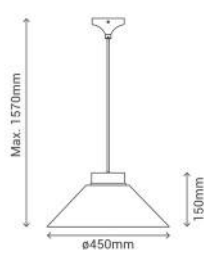

2009991



200998

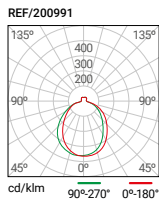

CARMEN

COLGANTES



201201



200992

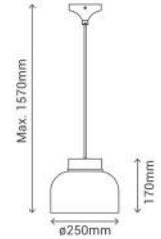

200993



201200

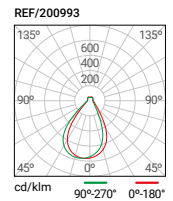

Material **M** **V**

9 W 600 lm 3000 K Blanco RAL 9016 / Negro RAL 9011



VALENTINA

COLGANTES

LED SMD AC 220-240V 50-60Hz

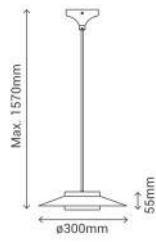
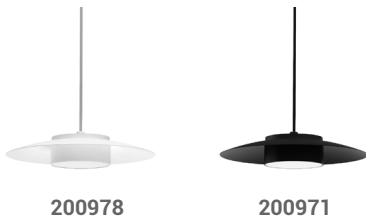

VALENTINA

COLGANTES

LED SMD AC 220-240V 50-60Hz

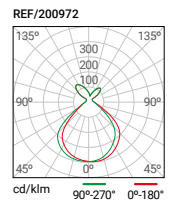
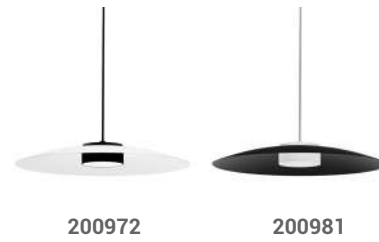
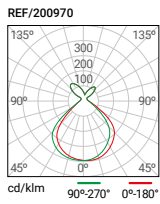
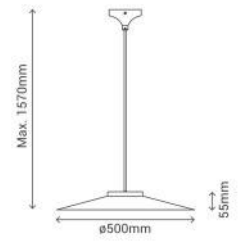
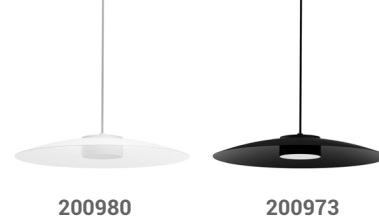

VALENTINA

COLGANTES

LED SMD AC 220-240V 50-60Hz

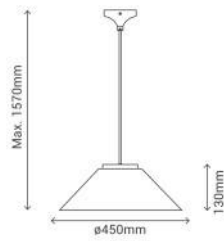

VALENTINA

COLGANTES

LED SMD AC 220-240V 50-60Hz

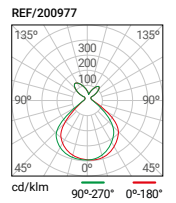
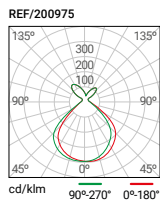
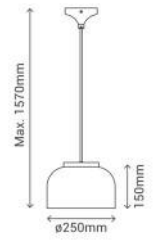
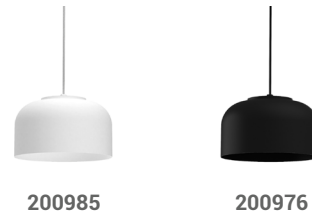

Material **M** **AC**



18 W 1200 lm 3000 K Blanco RAL 9016 / Negro RAL 9011





LUA

LUA

COLGANTES

AC 220-240V 50-60Hz

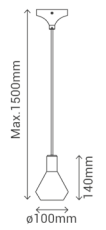

Material **M** **M**

200941	25 W max.	1 xGU10	Negro RAL 9011 / Negro RAL 9011
200943	25 W max.	1 xGU10	Blanco RAL 9016 / Blanco RAL 9016



IP 20



Embellecedor dorado incluido
Gold accessory included



LUA

COLGANTES

LED AC 220-240V 50-60Hz

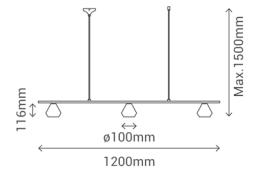

Material **M** **T**

200946	25 W max.	3 xGU10	Blanco RAL 9016 / Blanco RAL 9016
200942	25 W max.	3 xGU10	Negro RAL 9011 / Negro RAL 9011



IP 20



LUA

COLGANTES

LED AC 220-240V 50-60Hz

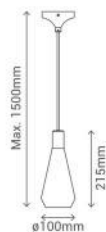

Material **M** **M**

200944	25 W max.	1 xGU10	Blanco RAL 9016 / Blanco RAL 9016
200945	25 W max.	1 xGU10	Negro RAL 9011 / Negro RAL 9011



IP 20



Embellecedor dorado incluido
Gold accessory included



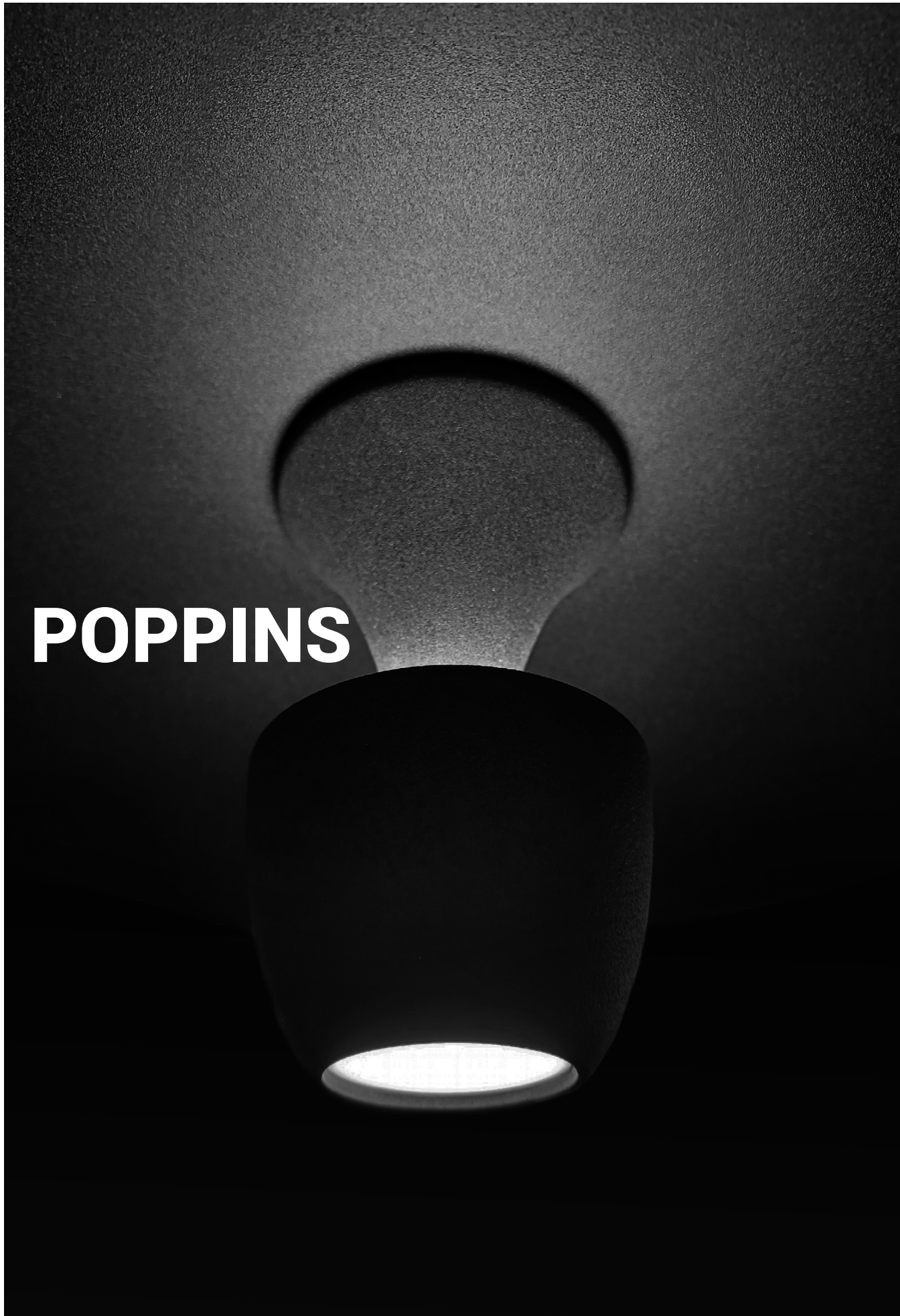

POPPINS



POPPINS

COLGANTES

LED SMD AC 200-240V 50-60Hz

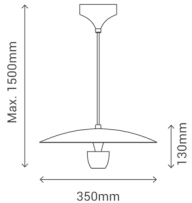

Material **M** **T**

200002	3+6 W	150+400 lm	3000 K	Negro RAL 9011
200005	3+6 W	150+400 lm	3000 K	Blanco RAL 9016

IP 20
 -20~+50°C

CRI80
 30°
 15000
 30000 h

REF/200002
 cd/klm 90°-270° 0°-180°

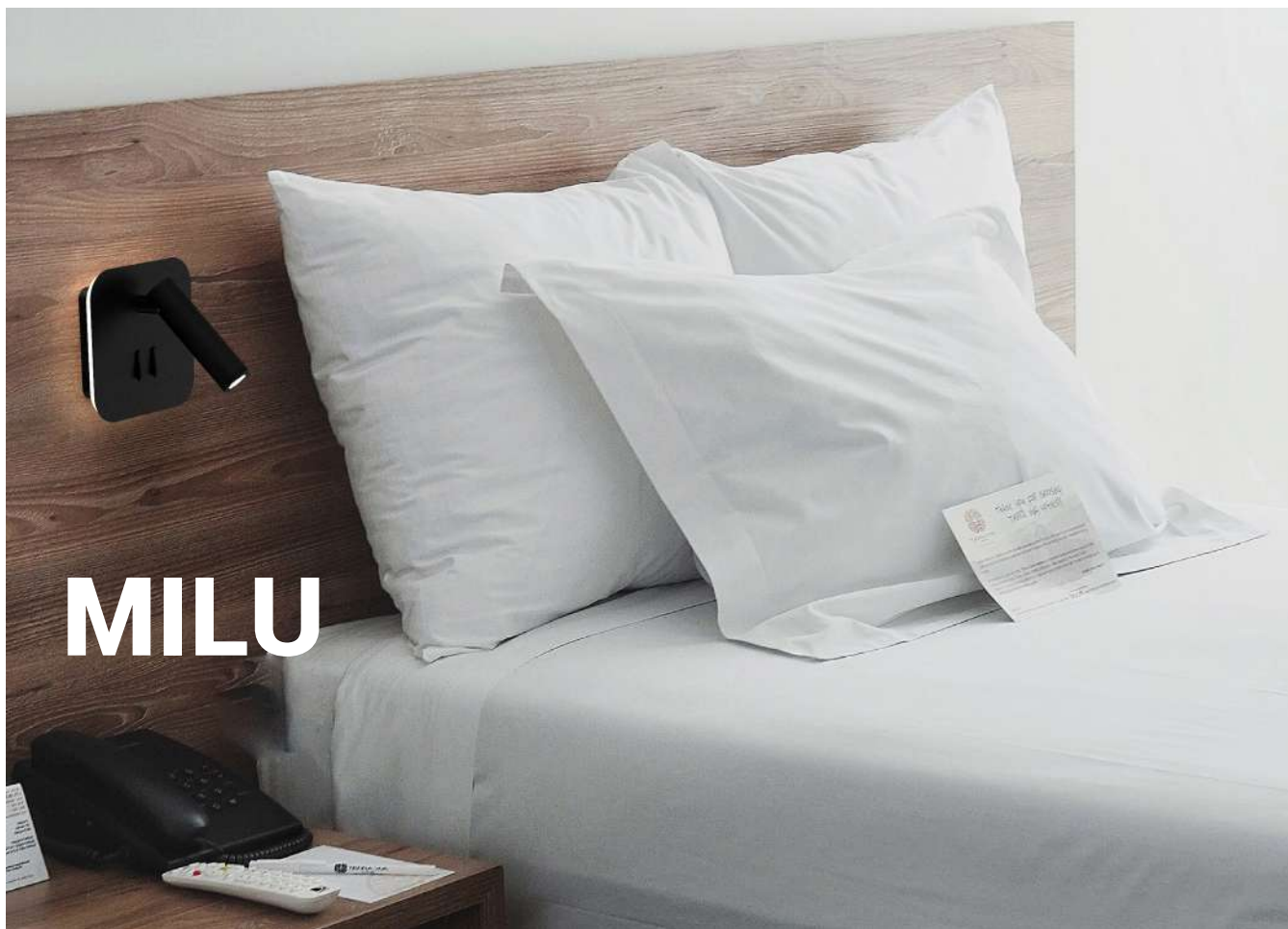

MILU

MILU

APLIQUE

LED COB AC 200-240V 50-60Hz

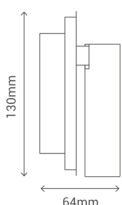

Material **M** **V**

167297	6+3 W	350+150 lm	3000 K	Negro RAL 9011
167298	6+3 W	350+150 lm	3000 K	Blanco RAL 9016

IP 20
 -20~+50°C

180°
LUZ INDIRECTA

CRI80
 30° +120°
 15000
 30000 h

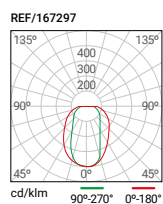



CLARA



CLARA

APLIQUE

LED COB AC 220-240 V 50-60 Hz

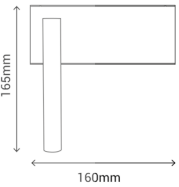

Material **M**

167299	3 W	150 lm	3000 K	Blanco RAL 9016
167400	3 W	150 lm	3000 K	Negro RAL 9011

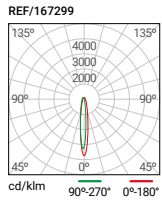







TRIME

TRIME

REGLETAS

LED SMD AC 220-240V 50-60Hz



Material **ABS**

112011 30W 2700 lm 3000-6000 K Blanco RAL 9003 / Gris



Material **ABS**

112012 40W 3700 lm 3000-6000 K Blanco RAL 9003 / Gris

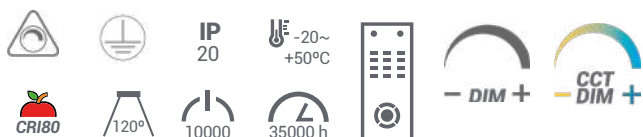

CRI80

120°

10000

35000 h



- DIM +

CCT DIM +



Material **ABS**

112013 60W 5400 lm 3000-6000 K Blanco RAL 9003 / Gris

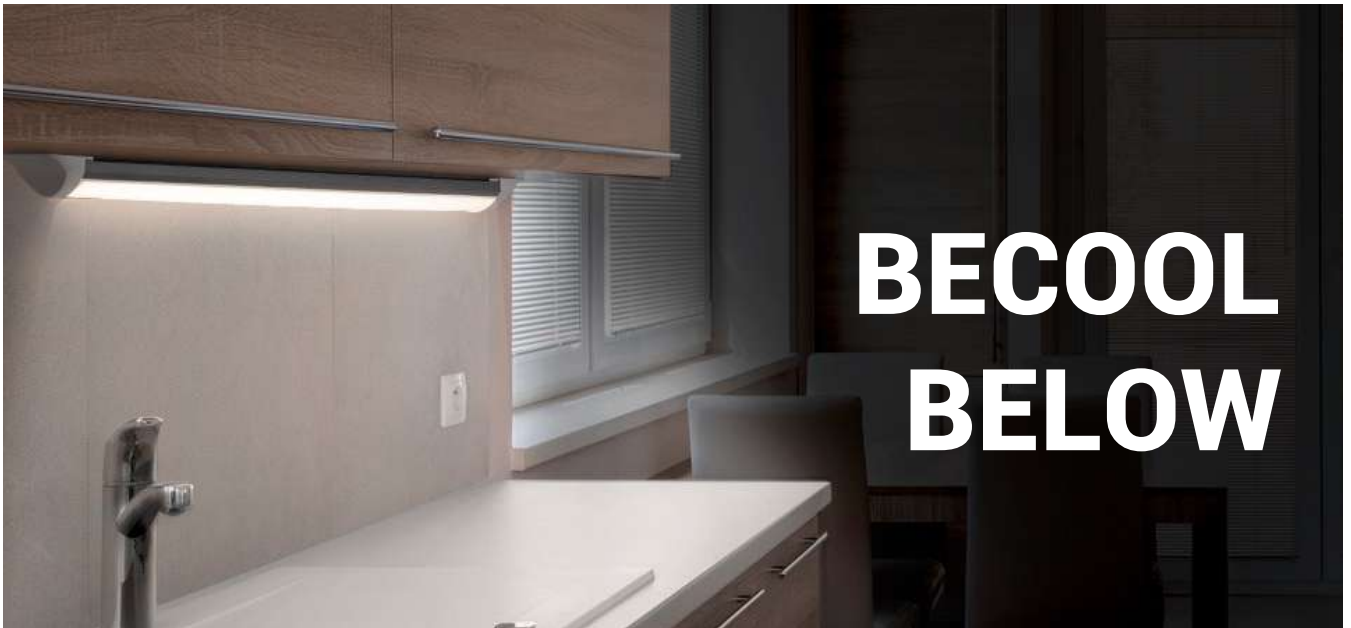

BECOOOL BELOW

BE-COOL

REGLETAS

LED SMD AC 220-240 V 50-60 Hz



Material **PC**

102025 18 W 1700 lm 4000 K Blanco RAL 9003

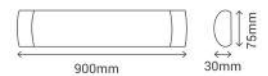

Material **PC**

102026 24 W 1920 lm 4000 K Blanco RAL 9003



Material **PC**

102027 40 W 3500 lm 4000 K Blanco RAL 9003



BELOW

REGLETAS

LED SMD AC 220-240 V 50-60 Hz



Material **A** **PC**

102011 24 W 2175 lm 4000 K Blanco RAL 9003

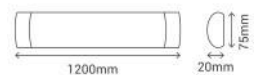

Material **A** **PC**

102041 45 W 3800 lm 4000 K Blanco RAL 9003



BELOW Disipador de aluminio
BELOW Aluminium disipator



KORU

KORU

TUBOS

LED SMD AC 200-240 V 50-60 Hz



Material 

101400	9 W	850 lm	4000 K	Blanco
101401	9 W	900 lm	6500 K	Blanco

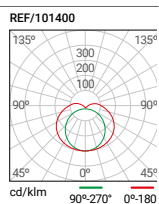

KORU

TUBOS

LED SMD AC 200-240 V 50-60 Hz



Material 

101402	18 W	1750 lm	4000 K	Blanco
101403	18 W	1800 lm	6500 K	Blanco



Cebador incluido - Conexión a un lateral

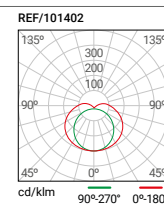

MONTAJE A / MOUNTING A

MONTAJE 1x / MOUNTING 1x

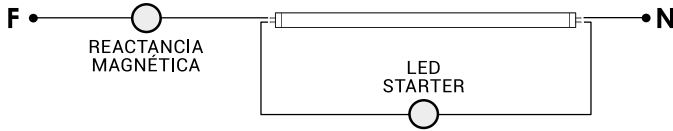

MONTAJE 2x / MOUNTING 2x

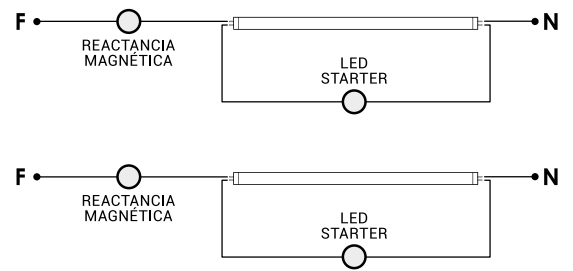

MONTAJE NO DISPONIBLE / MOUNTING NOT AVAILABLE

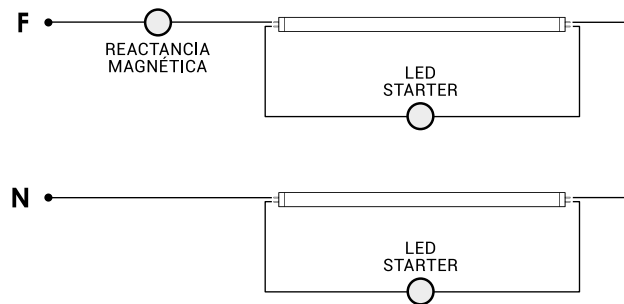

MONTAJE B / MOUNTING B

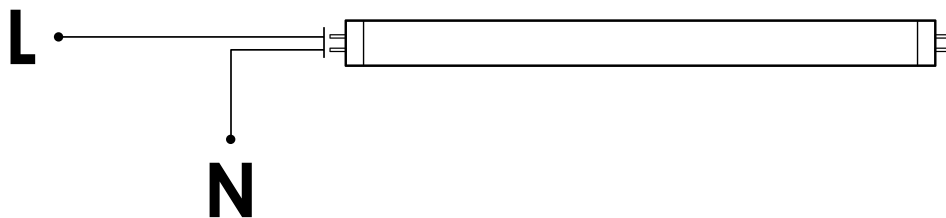

KORU

TUBOS

LED SMD AC 200-240V 50-60Hz

EXTREMO DE ALIMENTACIÓN / POWER END

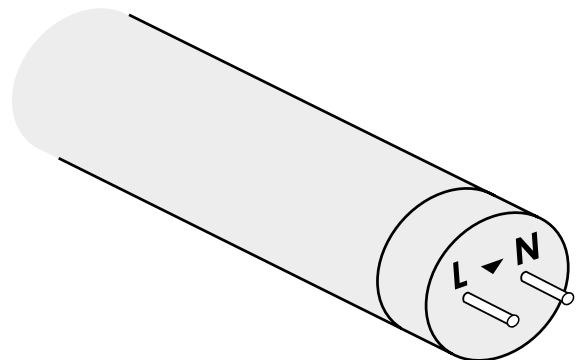
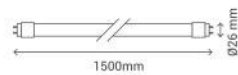

	Material	V		
101404	24 W	2350 lm	4000 K	Blanco
101405	24 W	2400 lm	6500 K	Blanco

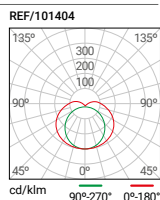





coffee m
БИЗНЕС
ОЦО 49
АГ ИНО 49
ЛАТЕ 5
ФЛЕТ ВАЙТ
РА
BULLE
44 53
49
56

ОЦО 49
АГ ИНО 37
ЛАТЕ 44
КА
AF
E

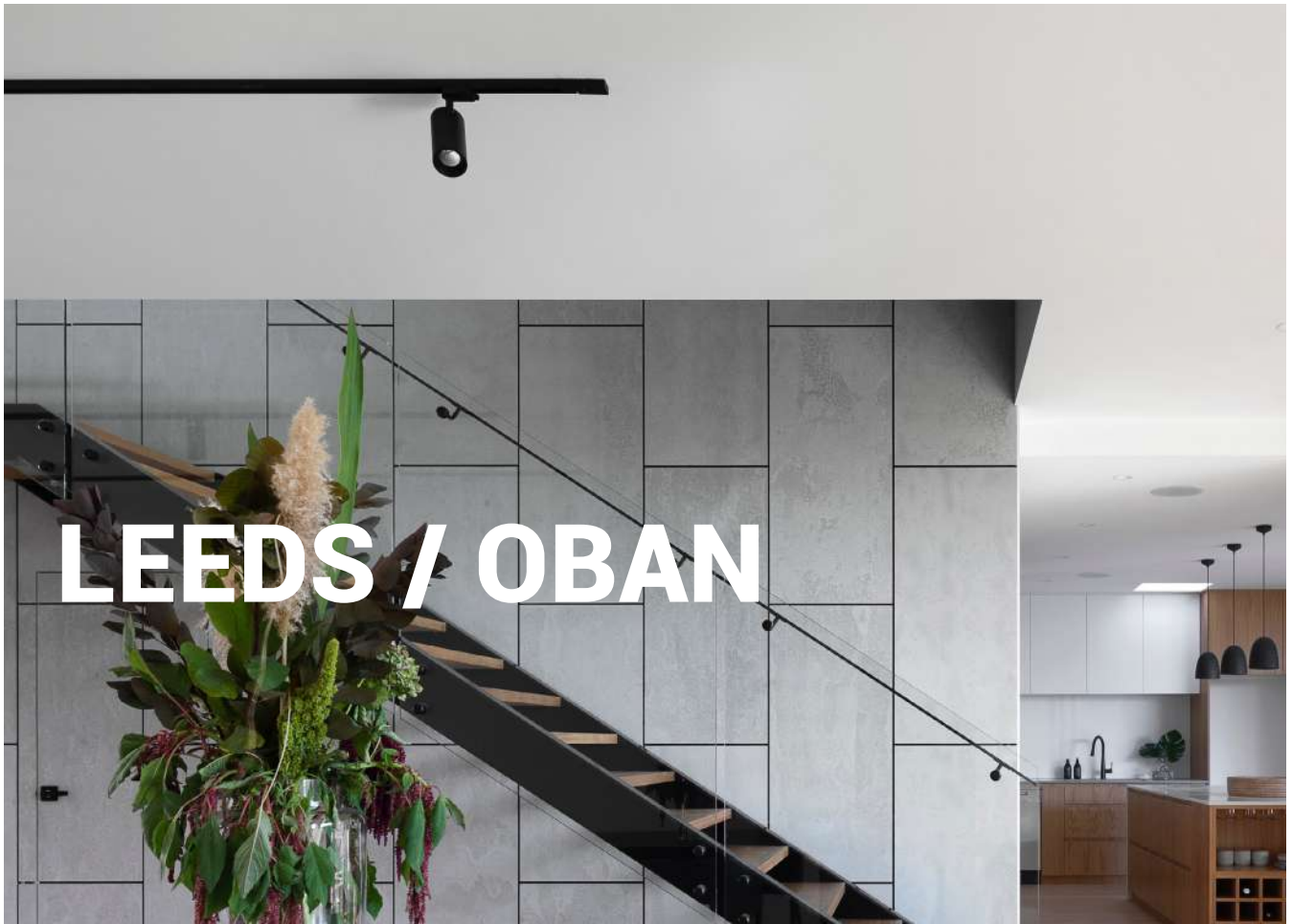

LEEDS / OBAN

LEEDS

FOCOS CARRIL MONOFÁSICO

LED COB AC 160-240V 50-60Hz



Material

307700	30 W	3000 lm	6000 K	Blanco RAL 9003
307800	30 W	3000 lm	4000 K	Blanco RAL 9003
307900	30 W	3000 lm	3000 K	Blanco RAL 9003
309100	30 W	3000 lm	6000 K	Negro RAL 9005
309200	30 W	3000 lm	4000 K	Negro RAL 9005
309300	30 W	3000 lm	3000 K	Negro RAL 9005

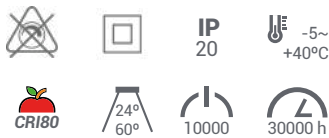

Accesorios / Accessories

- 320200 - Carril monofásico 2m Blanco
- 320700 - Carril monofásico 2m Negro
- 326300 - Colgador 1m para carril
- 304200 - Conector en línea para carril monofásico Negro
- 303800 - Conector en línea para carril monofásico Blanco
- 304300 - Conector TIPO L para carril monofásico Negro
- 303900 - Conector TIPO L para carril monofásico Blanco
- 304400 - Conector TIPO T para carril monofásico Negro
- 304000 - Conector TIPO T para carril monofásico Blanco

OBAN

FOCOS CARRIL MONOFÁSICO

LED COB AC 160-240V 50-60Hz



Material

306400	30 W	3000 lm	6000 K	Blanco RAL 9003
306500	30 W	3000 lm	4500 K	Blanco RAL 9003
306600	30 W	3000 lm	3000 K	Blanco RAL 9003
306100	30 W	3000 lm	6000 K	Negro RAL 9005
306200	30 W	3000 lm	4500 K	Negro RAL 9005
306300	30 W	3000 lm	3000 K	Negro RAL 9005

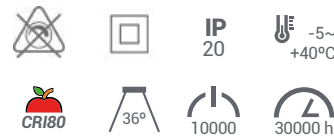

Accesorios / Accessories

- 320200 - Carril monofásico 2m Blanco
- 320700 - Carril monofásico 2m Negro
- 326300 - Colgador 1m para carril
- 304200 - Conector en línea para carril monofásico Negro
- 303800 - Conector en línea para carril monofásico Blanco
- 304300 - Conector TIPO L para carril monofásico Negro
- 303900 - Conector TIPO L para carril monofásico Blanco
- 304400 - Conector TIPO T para carril monofásico Negro
- 304000 - Conector TIPO T para carril monofásico Blanco



CORK



CORK

FOCOS CARRIL TRIFÁSICO

LED COB AC 160-240V 50-60Hz

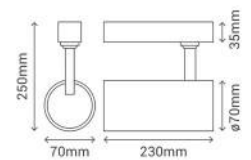
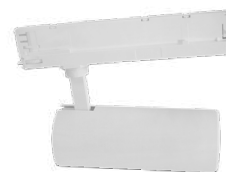

Material 

310100	32 W	3520 lm	6000 K	Blanco RAL 9003
310200	32 W	3520 lm	4500 K	Blanco RAL 9003
310300	32 W	3520 lm	3000 K	Blanco RAL 9003



IP
20

U_E -20~
+35°C



CRI85



36°



20000



50000 h

**DRIVER
PHILIPS**



360°

Accesorios / Accessories

320900 - Carril trifásico 2m Blanco

326300 - Colgador 1m para carril

321000 - Conector en línea para carril trifásico Blanco

321300 - Conector TIPO L para carril trifásico Blanco

321400 - Conector TIPO T para carril trifásico Blanco

REF/310100

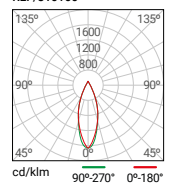

CARRY

CARRY

FOCOS CARRIL MONOFÁSICO

LED COB AC 220-240V 50-60Hz

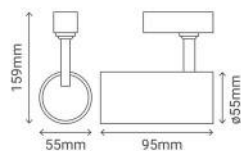

Material 

112080	3x8 W	3x550 lm	3000 K	Blanco RAL 9003
112081	3x8 W	3x550 lm	3000 K	Gris



IP
20

U_E -5~
+40°C



CRI82



60°



10000



20000 h



360°



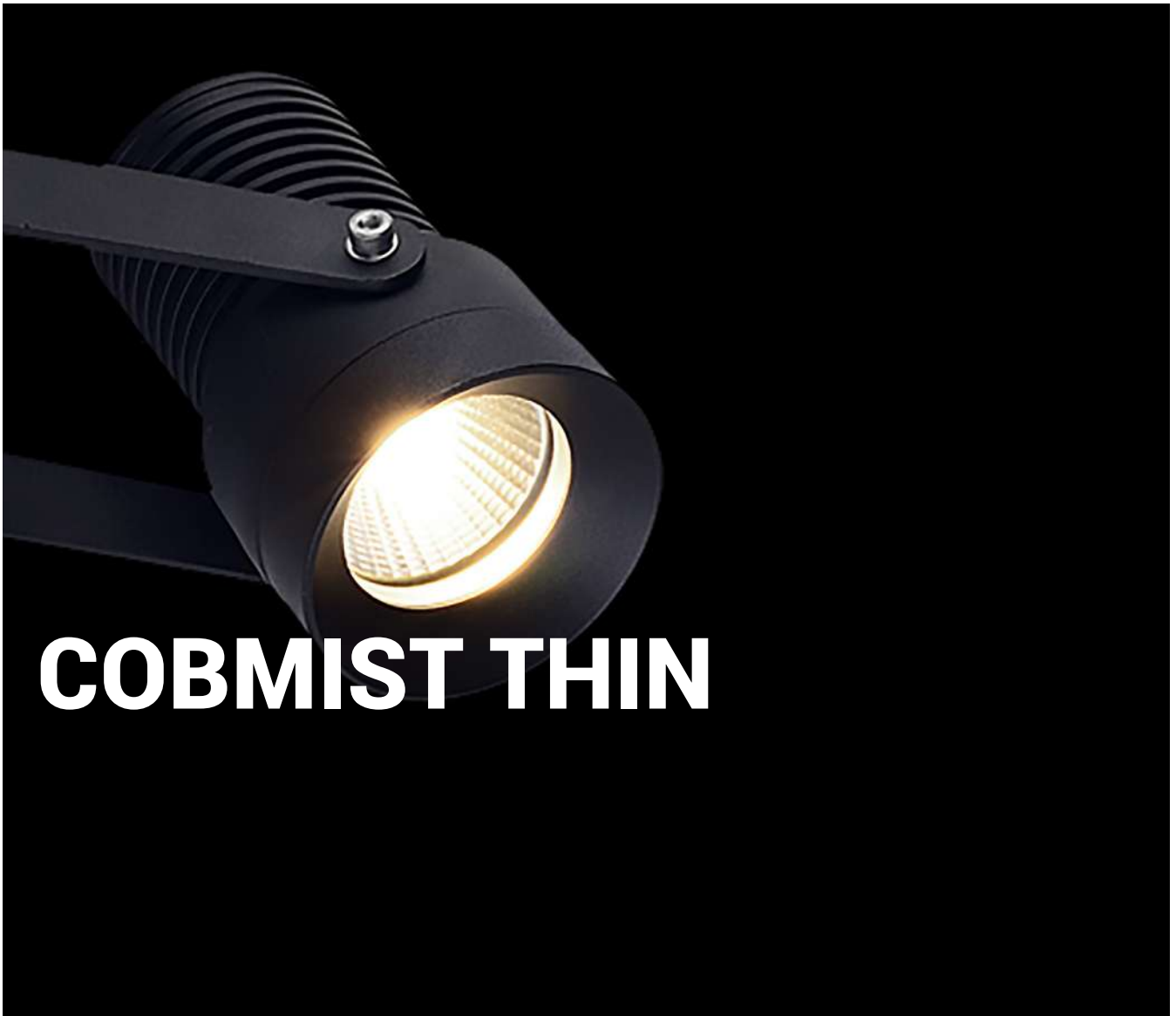

COBMIST THIN

PINCHOS / PROYECTOR

LED SMD AC 100-240V 50-60Hz

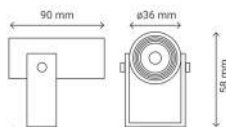

Material

111462	3 W	130 lm	2700 K	Negro RAL 9005
111050	3 W	130 lm	3000 K	Negro RAL 9005
111463	3 W	130 lm	4000 K	Negro RAL 9005

Accesorios / Accessories
80031 - Base metálica

REF/111050

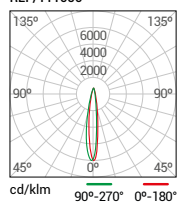

COBMIST THIN

PINCHOS / PROYECTOR

LED COB AC 220-240V 50-60Hz

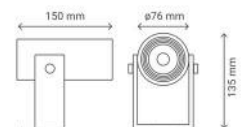

Material

111051	10 W	910 lm	3000 K	Negro RAL 9005
---------------	------	--------	--------	----------------





BIG A160

LED FILAMENTO AC 220-240V 50-60Hz

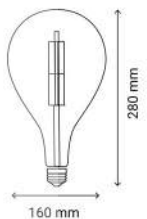

Material **V**

500731 12 W 1400 lm E27 2700 K Ambar

BOMBILLAS BIG

BIG G200

LED FILAMENTO AC 220-240V 50-60Hz

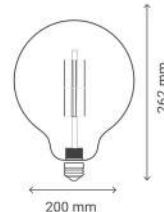

Material **V**

500732 12 W 1400 lm E27 2700 K Ambar



TRIAC
CRI80



360°



IP 20



-15~
+45°C



20000 h



- DIM +



TRIAC
CRI80



360°



IP 20



-15~
+45°C



20000 h



- DIM +



Powered by

tuya[®]

Intelligence
Inside



ES Conexión y control vía WIFI. Compatibilidad con Google home y Alexa. Más funcionalidades en la app que en el mando a distancia

EN Connection and control via WIFI Compatibility with Google home and Alexa More features in the app that on the remote

FR Connexion et contrôle via WIFI. Compatibilité avec Google home et Alexa. Plus fonctionnalités dans l'application que sur la télécommande

















PT Conexão e controle via Wi-Fi. Compatibilidade com o Google home e o Alexa. Mais recursos no aplicativo isso no controle remoto

WiFi

SULION IoT
APP FREE



alexa
Google Home

LED SMD								
	500349	5	470	E27	180°	DIM + CCT 3000-6500K	Blanco	Ø45 x 82mm
	500348	10	1055	E27	180°	DIM + CCT 3000-6500K	Blanco	Ø60 x 112mm
	500301	13	1521	E27	230°	DIM + CCT 3000-6500K	Blanco	Ø70 x 136mm
	500302	13	1521	E27	180°	DIM + CCT + RGB 3000-6500K	Blanco	Ø70 x 120mm
	500306	5	470	E14	160°	DIM + CCT 3000-6500K	Blanco	Ø37 x 108mm
	500311	5	450	GU10	120°	DIM + CCT 3000-6500K	Blanco	Ø56 x 50mm
	500312	5	450	GU10	120°	DIM + CCT + RGB 3000-6500K	Blanco	Ø56 x 50mm
	500308	10	1055	E27	230°	DIM + CCT 3000-6500K	Blanco	Ø95 x 137mm
LED FILAMENTO								
	500335	7	806	E27	360°	DIM + CCT 2200-6500K	Transparente	Ø60 x 105mm
	500350	7	780	E27	360°	DIM + CCT 2200-5500K	Milky	Ø60 x 105mm
	500396	7	600	E27	360°	DIM + CCT 2000-5000K	Ambar	Ø60 x 105mm
	500338	7	806	E27	360°	DIM + CCT 2200-6500K	Transparente	Ø125 x 175mm
	500351	7	780	E27	360°	DIM + CCT 2200-5500K	Milky	Ø125 x 175mm
	500395	7	600	E27	360°	DIM + CCT 2000-5000K	Ambar	Ø125 x 175mm
	500340	7	806	E27	360°	DIM + CCT 2200-6500K	Transparente	Ø64 x 140mm
	500353	7	600	E27	360°	DIM + CCT 1800-2200K	Ambar	Ø64 x 140mm



IP
20

-15~
+45°C



CRI80



AC 220-240V 50-60Hz





Conecta
Connect



Controla
Control



Monitorea
Monitoring



Agrupar
Group



CAM

EMPOTRABLES

LED SMD AC 220-240V 50Hz

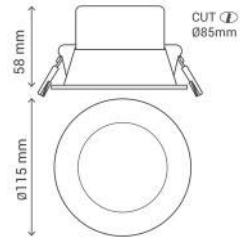

Material **ABS**

104400 9 W 765 lm 3000-6000 K Blanco RAL 9003

IP 20 -20~+40°C **RGB** **- CCT DIM +** **- DIM +**
CRI80 100° 15000 30000 h **APP** **WiFi**

HOLE

EMPOTRABLES

LED SMD AC 220-240V 50-60Hz



Material **A** **PC**

113209 18 W 1500 lm 3000-6000 K Blanco RAL 9003

IP 20 -20~+50°C **- CCT DIM +** **- DIM +**
Triac 120° 10000 30000 h **APP** **WiFi**
CRI80

REF/113209

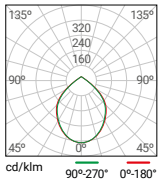

SURF

PLAFONES

LED SMD AC 220-240V 50-60Hz

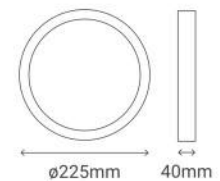

Material **A** **PC**

113200 18 W 1500 lm 3000-6000 K Blanco RAL 9003

IP 20 -20~+50°C **- CCT DIM +** **- DIM +**
CRI80 120° 10000 30000 h **APP** **WiFi**

REF/1132200

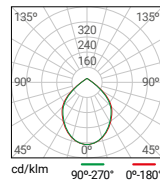

BREAKER

LED AC 90-250V 50-60Hz

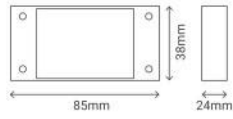

Material **ABS**

500410 2200 W

Blanco



IP
20

°E -10~
+50°C

100000

Controla con un solo click
Control with one click



PÁGINA EXPLICATIVA

Help page
Page explicative
Página explicativa

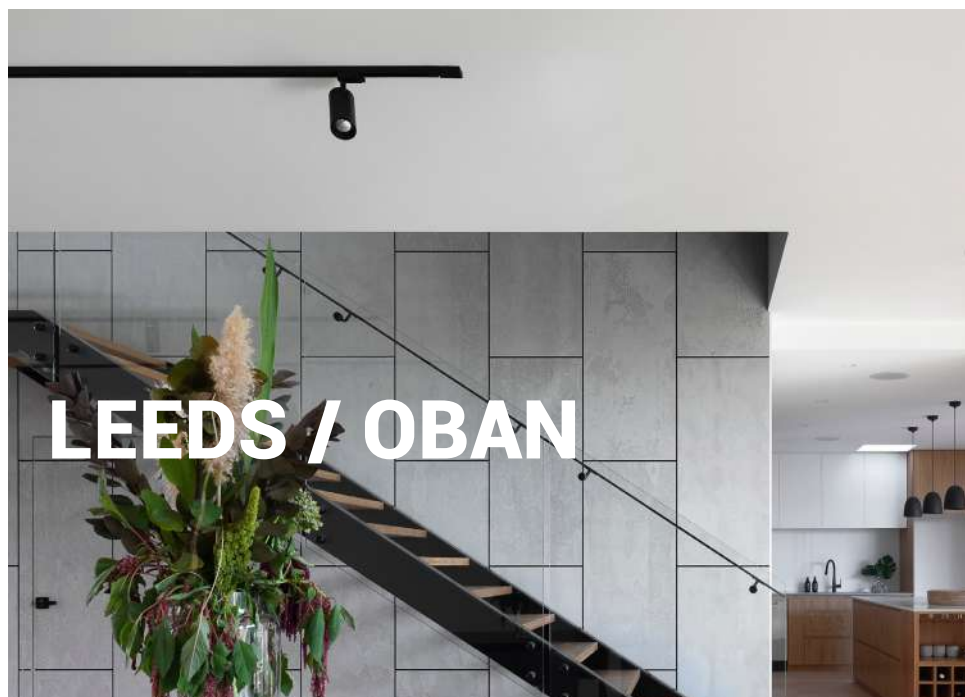

PRODUCTO
PRODUCT
PRODUIT
PRODUCTO

LEEDS

LED COB AC160-240V50-60Hz

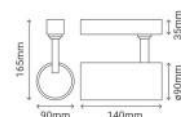

Material

307700	30 W	3000 lm	6000 K	Blanco RAL 9003
307800	30 W	3000 lm	4000 K	Blanco RAL 9003
307900	30 W	3000 lm	3000 K	Blanco RAL 9003
309100	30 W	3000 lm	6000 K	Negro RAL 9005
309200	30 W	3000 lm	4000 K	Negro RAL 9005
309300	30 W	3000 lm	3000 K	Negro RAL 9005



Accesorios / Accessories

320200 - Carril monofásico 2m Blanco
320700 - Carril monofásico 2m Negro
326300 - Colgador 1m para carril
304200 - Conector en línea para carril monofásico Negro
303800 - Conector en línea para carril monofásico Blanco
304300 - Conector TIPO L para carril monofásico Negro
303900 - Conector TIPO L para carril monofásico Blanco
304400 - Conector TIPO T para carril monofásico Negro
304000 - Conector TIPO T para carril monofásico Blanco

88

FOCOS CARRIL

OBAN

LED COB AC160-240V50-60Hz

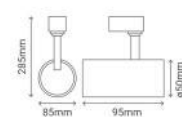

Material

306100	30 W	3000 lm	6000 K	Negro RAL 9005
306200	30 W	3000 lm	4500 K	Negro RAL 9005
306300	30 W	3000 lm	3000 K	Negro RAL 9005
306400	30 W	3000 lm	6000 K	Blanco RAL 9003
306500	30 W	3000 lm	4500 K	Blanco RAL 9003
306600	30 W	3000 lm	3000 K	Blanco RAL 9003



Accesorios / Accessories

320200 - Carril monofásico 2m Blanco
320700 - Carril monofásico 2m Negro
326300 - Colgador 1m para carril
304200 - Conector en línea para carril monofásico Negro
303800 - Conector en línea para carril monofásico Blanco
304300 - Conector TIPO L para carril monofásico Negro
303900 - Conector TIPO L para carril monofásico Blanco
304400 - Conector TIPO T para carril monofásico Negro
304000 - Conector TIPO T para carril monofásico Blanco

REFERENCIA
REFERENCE
RÉFÉRENCE
REFERÊNCIA

DATOS TÉCNICOS
TECHNICAL DATA
DONNÉES TECHNIQUES
DADOS TÉCNICOS

ACCESORIOS
ACCESSORIES
ACCESSOIRES
ACESSÓRIOS

ARQUITECTURAL | 2021



SECCIÓN
SECTION
SECTION
SEÇÃO

TIPOLOGÍA
TIPOLOGY
TYPOLOGIE
TIPOLOGIA

DIMENSIONES
SIZE
DIMENSIONS
DIMENSÕES

MATERIAL
MATERIAL
MATÉRIEL
MATERIAL

PLUS PRODUCTO
PLUS PRODUCTO
PLUS PRODUIT
PLUS PRODUTO

CORK

FOCOS CARRIL

LED COB AC 160-240V 50-60 Hz

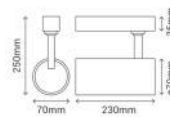

Material

310100	32 W	3520 lm	6000 K	Blanco RAL 9003
310200	32 W	3520 lm	8400 K	Blanco RAL 9003
310300	32 W	3520 lm	3000 K	Blanco RAL 9003



Accesorios / Accessories

320900 - Carril monofásico 2m Blanco

326300 - Colgador 1m para carril

321000 - Conector en línea para carril trifásico Blanco

321300 - Conector TIPO L para carril trifásico Blanco

321400 - Conector TIPO T para carril trifásico Blanco

REF/310100

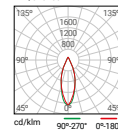

ICONOS

íconos | icônes | ícones

	ES	EN	FR	PT		ES	EN	FR	PT
	Producto nuevo	New product	Nouveau produit	Novo produto		APP	APP	APP	APP
	Tensión	Voltage	Tension	Voltagem		Altavoz	Speaker	Orateur	Alto falante
	Temperatura trabajo	Work temperature	Température travaille	Temperatura trabalho		Madera natural	Natural Wood	Bois Naturel	Madeira natural
	Factor de potencia	Power factor	Facteur de puissance	Fator de potência		Longitud de cable	Cable length	Longueur de câble	Comprimento do cabo
	Clase I	Class I	Classe électrique I	Classe I		Longitud de cable con enchufe	Cable length with plug	Longueur de câble avec plug	Comprimento do cabo com plugue
	Clase II	Class II	Classe électrique II	Classe II		Con interruptor	with swicht	avec interrupteur	com interruptor
	Grado de protección IP	IP protection degree	Degré de protection IP	Nível de proteção IP		Con mando	with remote control	avec télécommande	con controle remoto
	Bombilla incluida	Bulb included	Ampoule incluse	Lâmpada incluída		Orientable	Tilt herad	Tête pivotante	Ajustável
	Bombilla no incluida	Bulb not included	Ampoule non incluse	Não incluída		Oscilante	Oscillating	Oscillante	Oscilante
	Horas de vida	Lifetime	Heures de vie	Horas de vida		Salida de luz bilateral	Bidirectional light	Lumière bidirectionnelle	Luz bidireccional
	Número de encendidos	Number of ignitions	Nombre de démarrages	Número de ascendidos		Luz uindirecta	Indirect light	Lumière indirect	Luz indireta
	Peso	Weight	Poids	Peso		Extensible	Extensible	Extensible	Extensível
	Regulación en intensidad	Adjustable intensity	Intensité ajustable	Regulação em intensidade		Pintable	Paintable	Peinture	Pintable
	Regulable en intensidad	Adjustable intensity	Intensité ajustable	Ajustável em intensidade		Con toma USB	with USB connexion	Avec USB connexion	avec connexion USB
	Regulable en intensidad	Adjustable intensity	Intensité ajustable	Ajustável em intensidade		Modo noche	Night mode	Mode nuit	Modo noturno
	Regulación en temperatura de color	Adjustable colour intensity	Température de couleur ajustable	Regulação da temperatura de cor		Madera natural	Natural wood	Bois Naturel	Madeira natural
	3 temperaturas de color	3 Colour temperature	3 Température de couleur	3Temperatura de cor		Sobremesa	Table lamp	Lampes	Candeeiros de mesa
	Luz colores RGB	RGB colors Light	Lumière couleurs RGB	Luz cores RGB		Pié	Floor lamp	Lampadaires	Candeeiros de pé
	Ángulo de apertura	Opening angle	Angle d'ouverture	Ângulo de abertura		Colgante	Pendant lamp	Luminaire de suspension	Luminária de suspensão
	Índice de reproducción cromática	Colour rendering index	Indice de rendu des couleurs	Índice reprodução de cor		Aplique	Wall lamp	Appliquer	Aplique
	Producto domótico	Home automation product	Produit domotique	Produto domotico		Plafón	Ceiling lamp	Plafond	Lâmpada de teto
	Bluetooth APP	Bluetooth APP	Bluetooth APP	Bluetooth APP		Empotrable	Recessed	À encastrer	Encastramento

MATERIAL

Material | Matériel | Material

A



ALUMINIO | ALUMINIUM | ALUMINIUM | ALUMINIO

V



CRISTAL | GLASS | CRISTAL | VIDRIO

AC



ACRILICO | ACRYLIC | ACRYLIQUE | ACRÍLICO

ABS



ABS | ABS | ABS | ABS

S

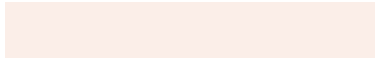

SILICONA | SILICONE | SILICONE | SILICONA

W



MADERA | WOOD | BOIS | MADEIRA

B



BAMBU | BAMBOO | BAMBOO | BAMBOO

R



RATAN | RATTAN | RATTAN | RATAN

C



CUERDA | CORD | CHAÎNE | FRAGMENTO

T



TEXTIL | TEXTILE | TEXTILE | TÊXTIL

Y



YESO | GYPSUM | PLÂTRE | GRESSO

C



CEMENTO | CONCRETE | BÉTON | CONCRETO

ÍNDICE INDEX

REF	Nombre	tipo	LED	Casquillo	página
25152	ACCESORIO	DRIVER			23
25153	ACCESORIO	DRIVER			23
50615	ACCESORIO	ESTRUCTURAS			33
50623	ACCESORIO	ESTRUCTURAS			33
50627	ACCESORIO	ESTRUCTURAS			35
50629	ACCESORIO	KIT			35
80031	ACCESORIO	ACCESORIOS			79
100752	THOR	EMPOTRABLES	LED		30
100753	THOR	EMPOTRABLES	LED		30
100759	THOR	EMPOTRABLES	LED		30
100760	THOR	EMPOTRABLES	LED		30
100770	CIFO	PLAFONES	LED		51
100818	ALPHA	PLAFONES	LED		50
100819	ALPHA	PLAFONES	LED		50
100832	PEAK	EMPOTRABLES	LED		35
100834	PEAK	EMPOTRABLES	LED		35
100836	PEAK	EMPOTRABLES	LED		35
100846	PLATE	EMPOTRABLES	LED		33
101056	PLATE	EMPOTRABLES	LED		33
101060	HOLEGLAS	EMPOTRABLES	LED		31
101061	HOLEGLAS	EMPOTRABLES	LED		31
101062	HOLEGLAS	EMPOTRABLES	LED		31
101149	BUGY	EMPOTRABLES	LED		29
101151	FRONT	EMPOTRABLES		GU10	37
101153	FRONT	EMPOTRABLES		GU10	37
101156	FRONT	EMPOTRABLES	LED	GU10	37
101172	BUGY	EMPOTRABLES	LED		29
101173	BUGY	EMPOTRABLES	LED		28
101174	BUGY	EMPOTRABLES	LED		28
101175	BUGY	EMPOTRABLES	LED		28
101176	BUGY	EMPOTRABLES	LED		28
101178	SAND	EMPOTRABLES		GU10	24
101179	SAND	EMPOTRABLES		GU10	24
101180	SAND	EMPOTRABLES	LED	GU10	24
101181	SAND	EMPOTRABLES	LED	GU10	24
101250	DUCK	EMPOTRABLES	LED		25
101254	DUCK	EMPOTRABLES	LED		25
101265	TURK	EMPOTRABLES	LED		27
101266	TURK	EMPOTRABLES	LED		27
101400	KORU	TUBOS	LED		72
101401	KORU	TUBOS	LED		72
101402	KORU	TUBOS	LED		72
101403	KORU	TUBOS	LED		72
101404	KORU	TUBOS	LED		73
101405	KORU	TUBOS	LED		73
101602	VISIO	EMPOTRABLES	LED		23
101606	VISIO	EMPOTRABLES		GU10	23
101618	VISIO	EMPOTRABLES		GU10	23
101621	VISIO	EMPOTRABLES		GU10	23
101624	VISIO	EMPOTRABLES		GU10	23
101630	VISIO	EMPOTRABLES	LED		23
101631	VISIO	EMPOTRABLES	LED		23
101753	THOR	EMPOTRABLES	LED		30
101759	THOR	EMPOTRABLES	LED		30

REF	Nombre	tipo	LED	Casquillo	página
102011	BELOW	REGLETAS	LED		71
102025	BE-COOL	REGLETAS	LED		71
102026	BE-COOL	REGLETAS	LED		71
102027	BE-COOL	REGLETAS	LED		71
102041	BELOW	REGLETAS	LED		71
102151	FRONT	EMPOTRABLES		AR111	37
102152	FRONT	EMPOTRABLES		AR111	37
102153	FRONT	EMPOTRABLES		AR111	37
102155	FRONT	EMPOTRABLES		GU10	37
102265	TURK	EMPOTRABLES	LED		27
102266	TURK	EMPOTRABLES	LED		27
103415	LINHA	PLAFONES	LED		49
103416	LINHA	PLAFONES	LED		49
103417	LINHA	PLAFONES	LED		49
103418	LINHA	PLAFONES	LED		49
104400	CAM	EMPOTRABLES	LED		86
105022	DOTFIX	EMPOTRABLES	LED		17
105025	DOTFIX	EMPOTRABLES	LED		17
105030	KIRA	PLAFONES	LED		53
105031	DOTFIX	EMPOTRABLES	LED		18
105032	DOTFIX	EMPOTRABLES	LED		16
105033	DOTFIX	EMPOTRABLES	LED		15
105035	KIRA	PLAFONES	LED		53
105040	KIRA	PLAFONES	LED		53
105042	DOTFIX	EMPOTRABLES	LED		16
105043	DOTFIX	EMPOTRABLES	LED		15
105045	KIRA	PLAFONES	LED		53
105046	DOTFIX	EMPOTRABLES	LED		16
105047	DOTFIX	EMPOTRABLES	LED		16
105048	DOTFIX	EMPOTRABLES	LED		16
105049	DOTFIX	EMPOTRABLES	LED		16
105050	DOTFIX	EMPOTRABLES	LED		16
105051	DOTFIX	EMPOTRABLES	LED		16
105052	DOTFIX	EMPOTRABLES	LED		15
105053	DOTFIX	EMPOTRABLES	LED		15
105054	DOTFIX	EMPOTRABLES	LED		15
105055	DOTFIX	EMPOTRABLES	LED		15
105056	DOTFIX	EMPOTRABLES	LED		15
105057	DOTFIX	EMPOTRABLES	LED		15
105058	DOTFIX	EMPOTRABLES	LED		15
105059	DOTFIX	EMPOTRABLES	LED		15
105061	DOTFIX	EMPOTRABLES	LED		15
105062	DOTFIX	EMPOTRABLES	LED		15
105063	DOTFIX	EMPOTRABLES	LED		17
105064	DOTFIX	EMPOTRABLES	LED		17
105065	DOTFIX	EMPOTRABLES	LED		17
105066	DOTFIX	EMPOTRABLES	LED		17
105067	DOTFIX	EMPOTRABLES	LED		17
105068	DOTFIX	EMPOTRABLES	LED		17
105069	DOTFIX	EMPOTRABLES	LED		18
105070	KIRA	PLAFONES	LED		53
105071	KIRA	PLAFONES	LED		53
105072	KIRA	PLAFONES	LED		53
105073	KIRA	COLGANTES	LED		54

REF	Nombre	tipo	LED	Casquillo	página
105074	KIRA	COLGANTES	LED		54
105075	KIRA	COLGANTES	LED		54
105076	KIRA	COLGANTES	LED		54
105077	KIRA	PLAFONES	LED		53
105078	KIRA	PLAFONES	LED		53
105079	KIRA	PLAFONES	LED		53
105080	KIRA	COLGANTES	LED		54
105081	KIRA	COLGANTES	LED		54
105082	KIRA	COLGANTES	LED		54
105083	KIRA	COLGANTES	LED		54
105084	KIRA	PLAFONES	LED		53
105085	KIRA	PLAFONES	LED		53
105086	KIRA	PLAFONES	LED		53
105087	KIRA	COLGANTES	LED		55
105088	KIRA	COLGANTES	LED		55
105089	KIRA	COLGANTES	LED		55
105090	KIRA	COLGANTES	LED		55
105091	KIRA	PLAFONES	LED		53
105092	KIRA	PLAFONES	LED		53
105093	KIRA	PLAFONES	LED		53
105094	KIRA	COLGANTES	LED		55
105095	KIRA	COLGANTES	LED		55
105096	KIRA	COLGANTES	LED		55
105097	KIRA	COLGANTES	LED		55
111029	ARUMFIX	EMPOTRABLES	LED		21
111030	ARUMFIX	EMPOTRABLES	LED		21
111031	ARUMFIX	EMPOTRABLES	LED		21
111032	ARUMFIX	EMPOTRABLES	LED		21
111041	LINDENFIX	BAÑADORES	LED		45
111042	RAYFIX	BAÑADORES	LED		45
111050	COBMIST THIN	PROYECTOR	LED		79
111051	COBMIST THIN	PROYECTOR	LED		79
111077	ARUMFIX	EMPOTRABLES	LED		21
111078	ARUMFIX	EMPOTRABLES	LED		21
111090	ASTON	BAÑADORES	LED		45
111462	COBMIST THIN	PROYECTOR	LED		79
111463	COBMIST THIN	PROYECTOR	LED		79
111634	MARTÍN	BAÑADORES	LED		43
111635	MARTÍN	BAÑADORES	LED		43
111636	MARTÍN	BAÑADORES	LED		43
111637	MARTÍN	BAÑADORES	LED		43
111638	MARTÍN	BAÑADORES	LED		43
111639	MARTÍN	BAÑADORES	LED		43
111770	CIFO	PLAFONES	LED		51
112011	TRIME	REGLETAS	LED		70
112012	TRIME	REGLETAS	LED		70
112013	TRIME	REGLETAS	LED		70
112080	CARRY	FOCOS CARRIL	LED		78
112081	CARRY	FOCOS CARRIL	LED		78
112168	TAPE	EMPOTRABLES	LED		32
112364	ARC	EMPOTRABLES	LED		24
112368	ARC	EMPOTRABLES	LED		24
112968	TAPE	EMPOTRABLES	LED		32
113150	PLATE	EMPOTRABLES	LED		33

REF	Nombre	tipo	LED	Casquillo	página
113200	SURF	PLAFONES	LED		86
113209	HOLE	EMPOTRABLES	LED		86
167297	MILU	APLIQUE	LED		66
167299	CLARA	APLIQUE	LED		67
167400	CLARA	APLIQUE	LED		67
200002	POPPINS	COLGANTES	LED		65
200005	POPPINS	COLGANTES	LED		65
200941	LUA	COLGANTES	LED	GU10	63
200942	LUA	COLGANTES	LED	GU10	63
200943	LUA	COLGANTES	LED	GU10	63
200944	LUA	COLGANTES	LED	GU10	63
200945	LUA	COLGANTES	LED	GU10	63
200946	LUA	COLGANTES	LED	GU10	63
200970	VALENTINA	COLGANTES	LED		61
200971	VALENTINA	COLGANTES	LED		61
200972	VALENTINA	COLGANTES	LED		61
200973	VALENTINA	COLGANTES	LED		61
200974	VALENTINA	COLGANTES	LED		61
200975	VALENTINA	COLGANTES	LED		61
200976	VALENTINA	COLGANTES	LED		61
200977	VALENTINA	COLGANTES	LED		61
200978	VALENTINA	COLGANTES	LED		61
200979	VALENTINA	COLGANTES	LED		61
200980	VALENTINA	COLGANTES	LED		61
200981	VALENTINA	COLGANTES	LED		61
200982	VALENTINA	COLGANTES	LED		61
200983	VALENTINA	COLGANTES	LED		61
200984	VALENTINA	COLGANTES	LED		61
200985	VALENTINA	COLGANTES	LED		61
200986	CARMEN	COLGANTES	LED		60
200987	CARMEN	COLGANTES	LED		60
200988	CARMEN	COLGANTES	LED		60
200989	CARMEN	COLGANTES	LED		60
200990	CARMEN	COLGANTES	LED		60
200991	CARMEN	COLGANTES	LED		60
200992	CARMEN	COLGANTES	LED		60
200993	CARMEN	COLGANTES	LED		60
200994	CARMEN	COLGANTES	LED		60
200995	CARMEN	COLGANTES	LED		60
200996	CARMEN	COLGANTES	LED		60
200997	CARMEN	COLGANTES	LED		60
200998	CARMEN	COLGANTES	LED		60
200999	CARMEN	COLGANTES	LED		60
201200	CARMEN	COLGANTES	LED		60
201201	CARMEN	COLGANTES	LED		60
306100	OBAN	FOCOS CARRIL	LED		76
306100	OBAN	FOCOS CARRIL	LED		88
306200	OBAN	FOCOS CARRIL	LED		76
306200	OBAN	FOCOS CARRIL	LED		88
306300	OBAN	FOCOS CARRIL	LED		76
306300	OBAN	FOCOS CARRIL	LED		88
306400	OBAN	FOCOS CARRIL	LED		76
306400	OBAN	FOCOS CARRIL	LED		88
306500	OBAN	FOCOS CARRIL	LED		76

ÍNDICE INDEX

REF	Nombre	tipo	LED	Casquillo	página
306500	OBAN	FOCOS CARRIL	LED		88
306600	OBAN	FOCOS CARRIL	LED		76
306600	OBAN	FOCOS CARRIL	LED		88
307700	LEEDS	FOCOS CARRIL	LED		76
307700	LEEDS	FOCOS CARRIL	LED		88
307800	LEEDS	FOCOS CARRIL	LED		76
307800	LEEDS	FOCOS CARRIL	LED		88
307900	LEEDS	FOCOS CARRIL	LED		76
307900	LEEDS	FOCOS CARRIL	LED		88
309100	LEEDS	FOCOS CARRIL	LED		76
309100	LEEDS	FOCOS CARRIL	LED		88
309200	LEEDS	FOCOS CARRIL	LED		76
309200	LEEDS	FOCOS CARRIL	LED		88
309300	LEEDS	FOCOS CARRIL	LED		76
309300	LEEDS	FOCOS CARRIL	LED		88
310100	CORK	FOCOS CARRIL	LED		77
310200	CORK	FOCOS CARRIL	LED		77
310300	CORK	FOCOS CARRIL	LED		77
320200	ACCESORIO	CARRIL			76
320700	ACCESORIO	CARRIL			76
320900	ACCESORIO	COLGANTES	LED		77
326300	ACCESORIO	ACCESORIOS			77
400089	BELY	BAÑADORES	LED		41
400090	BELY	BAÑADORES	LED		41
400110	BELY	BAÑADORES	LED		41
400111	BELY	BAÑADORES	LED		41
400112	BELY	BAÑADORES	LED		41
400113	BELY	BAÑADORES	LED		41
400114	BELY	BAÑADORES	LED		41
400115	BELY	BAÑADORES	LED		41
400116	BELY	BAÑADORES	LED		41
400117	BELY	BAÑADORES	LED		41
400118	BELY	BAÑADORES	LED		41
400119	BELY	BAÑADORES	LED		41
500301	A70	BOMBILLAS	LED	E27	84
500302	A70	BOMBILLAS	LED	E27	84
500306	C37	BOMBILLAS	LED	E27	84
500308	G100	BOMBILLAS	LED	E27	84
500311	GU10	BOMBILLAS	LED	GU10	84
500312	GU10	BOMBILLAS	LED	GU10	84
500335	A60	BOMBILLAS	LED	E27	84
500338	G125	BOMBILLAS	LED	E27	84
500340	ST64	BOMBILLAS	LED	E27	84
500348	A60	BOMBILLAS	LED	E27	84
500349	G45	BOMBILLAS	LED	E27	84
500350	A60	BOMBILLAS	LED	E27	84
500353	ST64	BOMBILLAS	LED	E27	84
500351	G125	BOMBILLAS	LED	E27	84
500395	G125	BOMBILLAS	LED	E27	84
500396	A60	BOMBILLAS	LED	E27	84
500410	BREAKER	DRIVER			87
500731	A160	BOMBILLAS BIG		E27	82
500732	G200	BOMBILLAS BIG		E27	82



 621262721

 <https://sulion.es/>

 +34 916774540

Calle Verano, 51 - Polígono Industrial Las Monjas -28850 Torrejón de Ardoz - Madrid (ESPAÑA)

